

HUGO GERNSBACK, Editor

# RADIO CRAFT

▼ AND POPULAR ELECTRONICS ▼



ELECTRONIC  
COMBAT RECORDER  
SEE PAGE 16

OCTOBER  
1944

25¢

CANADA 30¢

RADIO-ELECTRONICS IN ALL ITS PHASES

# MEMO TO *Purchasing Dept.*

*In our postwar radio sets, recommend you buy Solar Sealdite Tubular Capacitors - they're the best we've ever tested - the only way-molded units - Superior protection against moisture.*

*E.M.*

**ENGINEERING  
SPECIFY  
SOLAR  
DEPARTMENT**

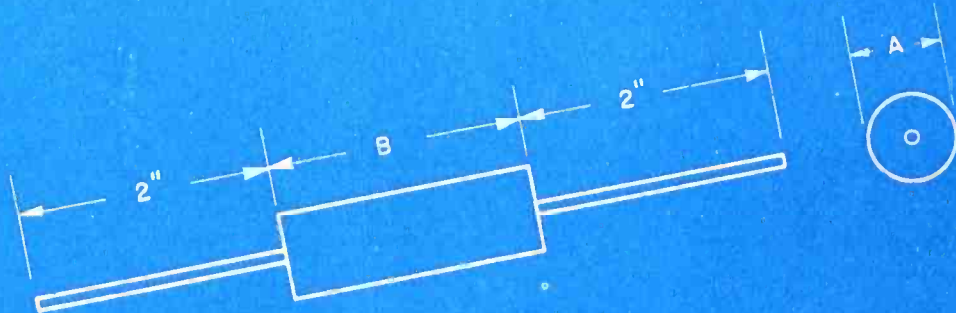

**LEADING MANUFACTURERS  
EVERYWHERE**

ART NO.	SOLAR PART NO.	CAP'Y MFD.	WKG. VOLTS	DIMENSIONS		DRAWN	DATE
				"A"	"B"		
49A40-1	S-0211	.001	600	3/8	1-3/16	<i>E.O.H.</i>	8/15/44
49A40-2	S-0215	.005	600	3/8	1-3/16	<i>M.</i>	DWG. No. 49A40
49A40-3	S-0221	.01	600	7/16	1-3/8	<i>J.C.</i>	ISSUE
49A40-4	S-0224	.02	600	7/16	1-5/8		
49A40-5	S-0230	.05	600	9/16	1-5/8		
49A40-6	S-0240	.1	600	9/16	2-1/8		

Prominent engineers consistently show their preference for Solar Capacitors. Solar pledges continued production of superior quality capacitors to merit that preference. Solar Manufacturing Corporation, 285 Madison Avenue, New York 17, N. Y.



**CAPACITORS &  
ELIM-O-STATS**



# A FREE LESSON SHOWED BILL HOW HE COULD MAKE GOOD PAY IN RADIO!

BILL, YOU'RE ALWAYS FOOLING WITH RADIO--OUR SET WON'T WORK--WILL YOU FIX IT?

I'LL TRY, MARY. I'LL SEE WHAT I CAN DO WITH IT TONIGHT

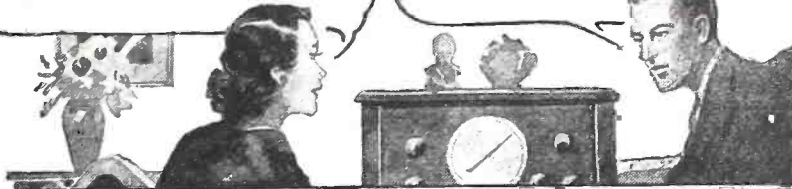

I CAN'T FIND OUT WHAT'S WRONG--GUESS I'LL MAKE A FOOL OF MYSELF WITH MARY



HELLO, BILL--GOT A TOUGH ONE TO FIX? LET ME HELP YOU



YES, JOE--I'M STUMPED--BUT SINCE WHEN ARE YOU A RADIO EXPERT?

I'VE BEEN STUDYING AT HOME WITH THE NATIONAL RADIO INSTITUTE. I JUST LANDED A SWELL RADIO JOB, TOO. LISTEN FOR THE CLICKS AS I SHORT THE GRID CONNECTIONS...HERE'S YOUR TROUBLE IN THE FIRST I.F. STAGE--I LEARNED THIS TEST BEFORE I EVEN STARTED THE COURSE, FROM A FREE LESSON THE N.R.I. SENT ME

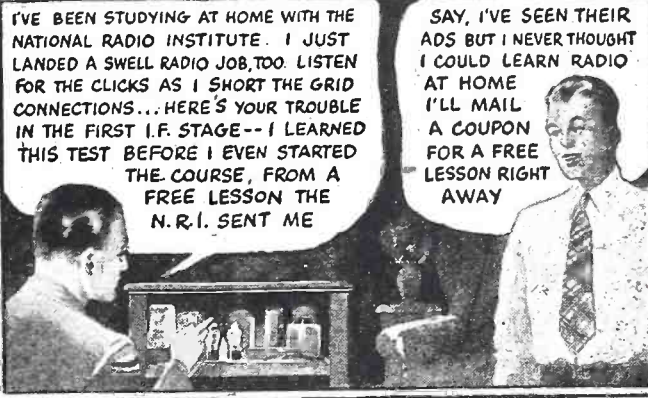

SAY, I'VE SEEN THEIR ADS BUT I NEVER THOUGHT I COULD LEARN RADIO AT HOME I'LL MAIL A COUPON FOR A FREE LESSON RIGHT AWAY

I'M CONVINCED NOW THAT THE N.R.I. COURSE IS PRACTICAL AND THOROUGH. I'LL ENROLL NOW. THEN I CAN MAKE EXTRA MONEY FIXING RADIOS IN SPARE TIME WHILE LEARNING



SOON I CAN HAVE MY OWN FULL-TIME RADIO REPAIR BUSINESS, OR BE READY FOR A GOOD JOB IN A BROADCASTING STATION, AVIATION RADIO, POLICE RADIO OR SOME OTHER BUSY RADIO FIELD

YOU CERTAINLY KNOW RADIO. SOUNDS AS GOOD AS THE DAY I BOUGHT IT!



THANKS! I WAS JUST A TINKERER A FEW MONTHS AGO, BEFORE I STARTED THE N.R.I. COURSE--BUT N.R.I.'S "50-50 METHOD" GIVES A FELLOW THE PRACTICAL KNOWLEDGE AND EXPERIENCE TO BE A SUCCESSFUL RADIO TECHNICIAN

OH, BILL--I'M SO GLAD I ASKED YOU TO FIX OUR RADIO! IT GOT YOU STARTED THINKING ABOUT RADIO AS A CAREER, AND NOW YOU'RE GOING AHEAD SO FAST!



YES, OUR WORRIES ARE OVER. I HAVE A GOOD JOB AND THERE'S A BRIGHT FUTURE FOR US IN RADIO

## I will send you a Lesson on Radio Servicing Tips **FREE** TO SHOW HOW PRACTICAL IT IS TO TRAIN AT HOME FOR **GOOD JOBS IN RADIO**

I want to give every man who's interested in Radio, either professionally or as a hobby, a copy of my Sample Lesson, "Radio Receiver Troubles--Their Cause and Remedy"--absolutely FREE! It's a valuable lesson. Study it--keep it--use it--without obligation! And with it I'll send my FREE 64-page, illustrated book, "How to Train at Home and Win Rich Rewards in Radio." It describes many fascinating jobs in Radio, tells how N.R.I. trains you at home in spare time, how you get practical experience with SIX KITS OF RADIO PARTS I send.

You'll see why my easy-to-grasp lessons have paved the way to good pay for hundreds of other men. But even if you never go any further, this Sample Lesson is worth having. I will send it to you without obligation. MAIL THE COUPON!



### Big Demand Now For Well-Trained Radio Technicians, Operators

There's a shortage today of capable Radio Technicians and Operators. Fixing Radios pays better now than for years. With new Radios out of production, fixing old sets, which were formerly traded in, adds greatly to the normal number of servicing jobs.

Broadcasting Stations, Aviation and Police Radio, and other Radio branches are searching for Operators and Technicians. Radio Manufacturers employ many trained men. And think of the NEW jobs that Television, Electronics, and Frequency Modulation will open up after the war!

**Our 30th Year of Training Men for Success in Radio**

**My Radio Course Includes Training in  
TELEVISION • ELECTRONICS • FREQUENCY MODULATION**

### Many Beginners Soon Make \$5, \$10 a Week EXTRA in Spare Time

As soon as you enroll for my Course I start sending you EXTRA MONEY JOB SHEETS that show you how to earn \$5 to \$10 a week EXTRA in spare time while still learning.

#### Mail Coupon for Free Lesson and Book

The opportunity the war has given beginners to get started in Radio may never be repeated. So take the first step at once. Get my FREE Lesson and 64-page, illustrated book. No obligation. Just mail coupon in an envelope or paste it on a penny postal.—J. E. SMITH, President, Dept. 4KX, National Radio Institute, Washington 9, D.C.

### You Build These and Other Radio Circuits with 6 BIG KITS OF PARTS I SEND YOU!

By the time you've conducted 60 sets of Experiments with Radio Parts I supply, made hundreds of measurements and adjustments, you'll have valuable PRACTICAL Radio experience for a good full or part-time Radio job!

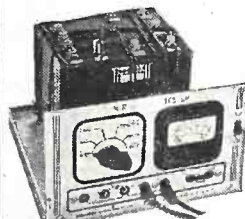

MEASURING INSTRUMENT (above) you build early in Course. Use it in practical Radio work to make EXTRA money. Vacuum tube multimeter, measures A.C., D.C., and R.F. volts, D.C. currents, resistance, receiver output.

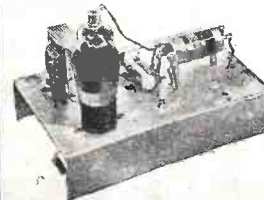

A. M. SIGNAL-GENERATOR (left) build it yourself! Provides amplitude-modulated signals for test and experimental purposes. Gives valuable practice!

SUPERHETERODYNE CIRCUIT (right) Preselector, oscillator-mixer-first detector, i.f. stage, diode detector—a.v.c. stage, audio stage. Bring in local and distant stations on this circuit you build yourself!



## GET BOTH 64 PAGE BOOK **FREE** SAMPLE LESSON

Mr. J. E. SMITH, President, Dept. 4KX  
NATIONAL RADIO INSTITUTE, Washington 9, D. C.

Mail me FREE, without obligation, Sample Lesson and 64-page book, "How to Train at Home and Win Rich Rewards in Radio." (No salesman will call. Write plainly.)

Age.....  
Name.....  
Address.....  
City..... State..... 14X1

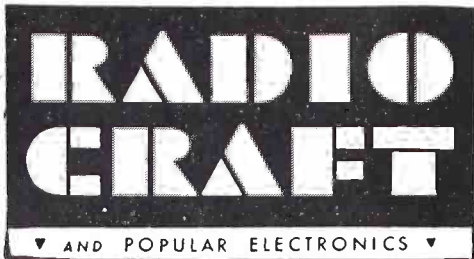

MEMBER  
AUDIT BUREAU OF CIRCULATIONS

HUGO GERNSBACK, *Editor-in-Chief*  
FRED SHUNAMAN, *Associate Editor*  
I. QUEEN, *Editorial Associate*  
ELMER FULLER, *Shortwave Editor*  
A. PASCALE, *Production Manager*  
G. ALIQUO, *Circulation Manager*  
JOHN J. LAMSON, *Advertising Director*  
ALFRED STERN, *Promotion Manager*

### IN THE NEXT ISSUE

Tube Transconductance Tester  
The Oscilloscope in Industry  
"Station Riding" Interference  
Noiseless Recording Methods  
Tracking Troubles in Supers

Published by Radcraft Publications, Inc.  
Publication Office: 29 Worthington  
Street, Springfield 3, Mass.

Editorial and Advertising Offices: 25  
West Broadway, Tel. RE2-9690, New  
York 7, N. Y.

Chicago Advertising Office: Radio-Craft,  
520 North Michigan Avenue, Tel. Su-  
perior 7306, Chicago 11, Ill.

Cleveland Advertising Office: 405 Erie  
Bldg., Cleveland, Ohio. Burdette Phil-  
lips, Manager. Tel. Main 9645.

RADIO-CRAFT is published monthly,  
on the 25th of the month preceding that  
of date; subscription price is \$2.50 per  
year in U. S. (In foreign countries, 75c  
additional per year to cover postage;  
Canada, 50c additional.) Special rates  
for members of the Armed forces in  
U. S., or those addressed by A.P.O. or  
F.P.O. mail, \$2.00. Entered at the post  
office at Springfield as second-class mat-  
ter under the Act of March 3, 1879. All  
communications about subscriptions  
should be addressed to: Circulation  
Manager, Radio-Craft, 29 Worthington  
St., Springfield 3, Mass.

Notice of CHANGE of ADDRESS should  
reach us at least one month in advance. When  
ordering a change, please furnish an address  
stencil impression from a recent wrapper if  
you can. Address changes cannot be made  
without the old address as well as the new.

Foreign Agents  
London—Atlas Publishing and Distributing  
Co., Ltd., 18 Bride Lane, Fleet St., London,  
E.C. 4.  
Melbourne—McGill's Agency, 179 Elizabeth  
St., Australia.

Text and illustrations of this magazine are  
copyright and must not be reproduced without  
permission of the copyright owners.  
Copyright, 1944, Radcraft Publications, Inc.

# Contents October, 1944 Volume XVI, No. 1

Editorial: Radio Opportunities.....by Hugo Gernsback 11  
Radio-Electronics Monthly Review..... 12

## ELECTRONICS

Tube of the Future.....by Capt. Eugene E. Skinner 17  
Electronic Aids to Good Hearing.....by I. Queen 20  
Oscilloscopes in Industry.....by Werner Muller 23  
Electronics and Air Power, Part II.....by Ted Powell 27  
Industrial Electronics, Part VIII.....by Raymond F. Yates 28  
Practical Electronics, Part VII.....by Fred Shunaman 29

## WARTIME RADIO

Enemy Finders.....by Eric Leslie 14  
Combat Recorder (Cover Feature)..... 16

## RADIO TRAINING

Broadcast Equipment, Part II.....by Don C. Hoefler 25

## SERVICING

Priority Problems.....by Eugene Carrington 30

## SOUND

Speech Amplifier Design.....by Robert F. Scott 19

## TEST INSTRUMENTS

3-Tube Voltmeter.....by John F. Coolen 24

## DEPARTMENTS

World-Wide Station List.....Edited by Elmer R. Fuller 32  
New Radio-Electronic Devices..... 36  
The Question Box..... 38  
Try This One!..... 40  
Radio-Electronic Circuits..... 42  
Progress in Invention.....Conducted by I. Queen 44  
Technotes..... 58  
The Mail Bag..... 60  
Book Reviews..... 63



### ON THE COVER

An electronic device for making on-the-spot re-  
cordings of actual battle sounds is the subject of  
our cover. This is identical with the apparatus used  
by John Hix in his D-Day invasion broadcast. Other  
important recordings were made on this instrument,  
notably the attack on Gen. de Gaulle in Paris.

# LIKE MONEY FROM HOME

## \$200<sup>00</sup> each month for Prize Winning Letters!



**\$200<sup>00</sup> in prizes every month**  
**\$100.00 first prize, \$50.00 second prize, \$25.00**  
**third prize, \$15.00 fourth prize, \$10.00 fifth prize,**  
**plus \$1.00 for every letter received.**

Here we go again. Another great Hallicrafters letter contest for service men. Wherever you are, whenever you see this announcement, drop us a line. Write and tell us your first hand experience with *all* types of radio communications built by Hallicrafters, including the famous SCR-299.

*It's just like money from home!* Write today to get your share. Tell us your story in your own way. You can't lose and you *can* win as high as \$100.00.

### Rules for the Contest

Hallicrafters will give \$200.00 for the best letters received during each of the six months of September, October, November, December, 1944, January, and February, 1945. (Deadline: Your letter must be received by midnight, the last day of each month.)

For every serious letter received, Hallicrafters will send \$1.00 so even if you do not win a big prize your time will not be in vain. Your letter will become the property of Hallicrafters and they will have the right to reproduce it in a Hallicrafters advertisement. Write as many letters as you wish. V-mail letters will do.

Open to service men around the world. Wherever you are, whenever you see this ad, drop us a line. Monthly winners will be notified immediately upon judging.



Service men all over the world are learning that the name "Hallicrafters" stands for quality in radio equipment. There's a great and exciting future ahead for short wave enthusiasts. In peace time Hallicrafters will continue to build "the radio man's radio" and that means the best that can be made. There will be a set for you in our postwar line.



BUY A WAR BOND TODAY!

# hallicrafters RADIO

THE HALLICRAFTERS COMPANY, MANUFACTURERS OF RADIO AND ELECTRONIC EQUIPMENT, CHICAGO 16, U.S.A.

# How the HT-4 took it at 134° in the shade . . .

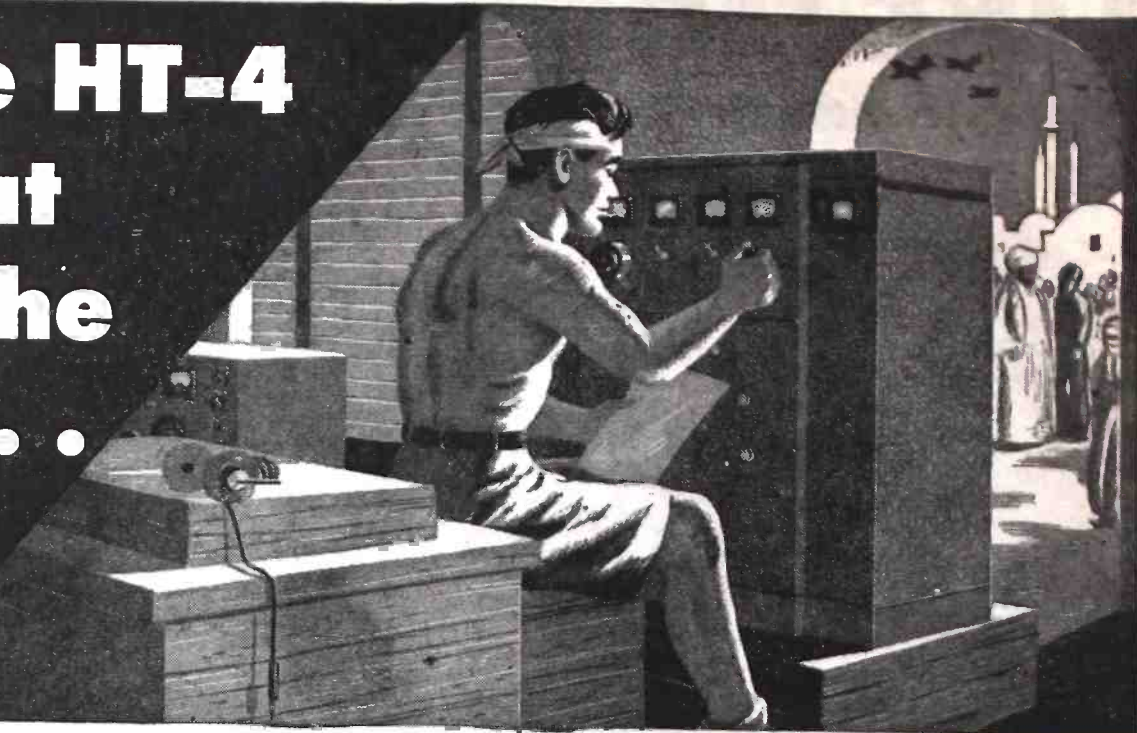

*The following is quoted from a letter marked "Somewhere in Libya" signed by Captain Charles A. Koppe, 57th AACS Group, USAAF: "The writer just spent a year in Persia. Most of the time along the Persian Gulf where it really gets HOT! We operated one of your HT-4-B Transmitters near a place called Abadan. The transmitter performed very satisfactorily under the most unfavorable conditions. I doubt that your engineers ever dreamed that one of your rigs would be called upon to perform in a place where for 5 days and nights the temperature never dropped below 117 degrees and in fact it got up to 134 degrees during the daytime, that is "in the shade" temperature, the humidity was high and the air salty. Actually the transmitter got much hotter than that as it was installed in a brick building and no air conditioning, not even an exhaust fan. The HT-4-B was used on voice and gave very little trouble. One day the piece of bakelite under the phone/cw switch caught on fire but this was easily repaired. During the so called winter season, the temperature actually got as low as 36 degrees one day, we had a little trouble with mice crawling under the rig, which was set up on two 4x4 wooden sleepers. It seems the mice liked the heat and they would crawl up under the transmitter and get lodged in between the rectifier sockets and the frame when the operator switched on the transmitter the mice would fry, usually a fuse would blow but no other damage was done. We never did figure why the mice liked the Hallcrafters best. There were several other transmitters in the room but they always seemed to pick the HT-4-B; guess they were pretty smart mice!"*

*Just one of hundreds of real life experiences of Hallicrafters equipment. Out of this valuable experience will come your peace time short wave radio.*



**★BUY A WAR BOND TODAY!**



## hallicrafters RADIO



● THE HALLICRAFTERS COMPANY • MANUFACTURERS OF RADIO AND ELECTRONIC EQUIPMENT • CHICAGO 16, U. S. A. ●

# SPRAYBERRY RADIO TRAINING

*Gives you Both*

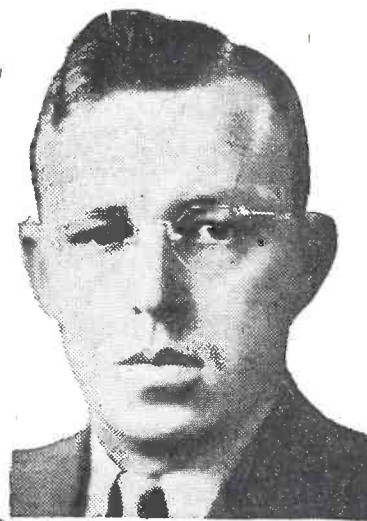

**FULL RADIO SET SUPPLIED FOR SHOP PRACTICE!**

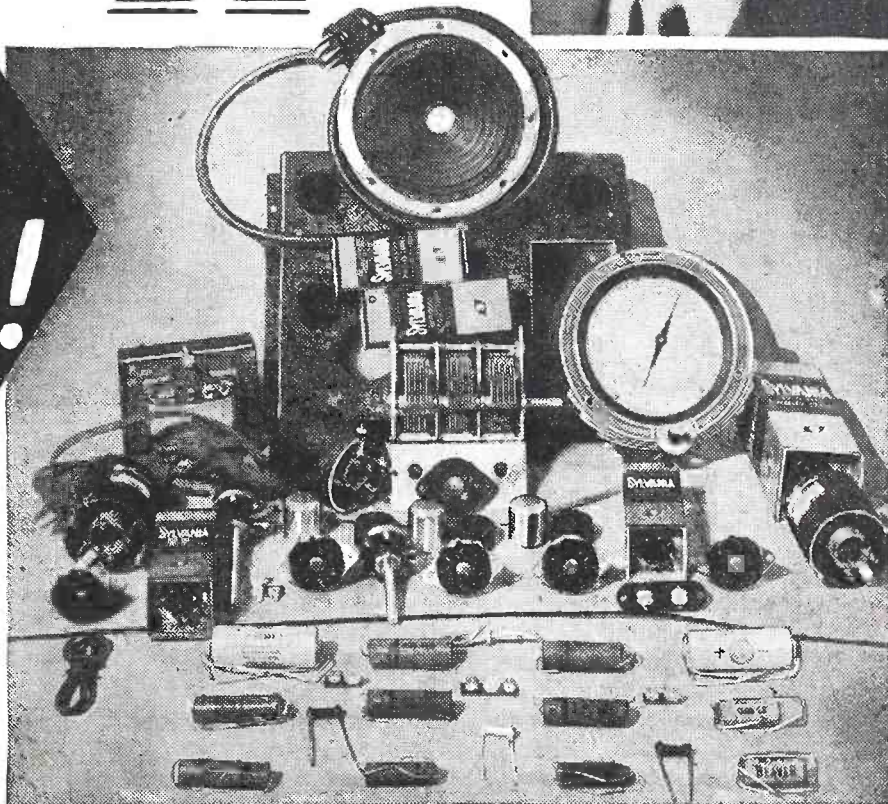

## HERE'S THE ONE PRACTICAL WAY TO TRAIN FOR BIG EARNINGS AHEAD IN RADIO-ELECTRONICS & TELEVISION

The offer I make you here is the opportunity of a lifetime. It's your big chance to get ready for a wonderful future in the swiftly expanding field of Radio-Electronics INCLUDING Radio, Television, Frequency Modulation and Industrial Electronics. Be wise! NOW'S the time to start. No previous experience is necessary. The Sprayberry Course starts right at the beginning of Radio. You can't get lost. It gets the various subjects across in such a clear, simple way that you understand and remember.

### I'll Show You a New, Fast Way to Test Radio Sets Without Manufactured Equipment

The very same Radio Parts I supply with your course for gaining pre-experience in Radio Repair work may be adapted through an exclusive Sprayberry wiring procedure to serve for complete, fast, accurate Radio Receiver trouble-shooting. Thus under Sprayberry methods you do not have one cent of outlay for manufactured Test Equipment which is not only expensive but scarce.

### Prepares You For a Business of Your Own or Good Radio Jobs . . . Civilian or Military

My training will give you the broad, fundamental principles so necessary as a background no matter which branch of Radio you wish to specialize in. I make it easy for you to learn Radio Set Repair and Installation Work. I teach you how to install and repair Electronic Equipment. If you enter the Army, Navy or Marines, my training will help you win higher rating and better pay.

### JUST OUT! FREE! HOW TO READ RADIO DIAGRAMS AND SYMBOLS

... a valuable new book which explains in simple, non-technical English how to read and understand any Radio Set Diagram. Provides the quick key to analyzing any Radio circuit. Includes translations of all Radio symbols. Send for this FREE book now while supply lasts and along with it I will send you another big FREE book describing my Radio-Electronic training.

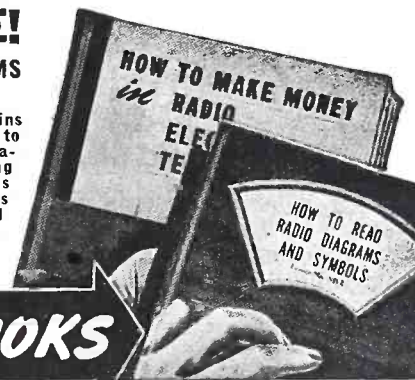

### GET FREE BOOKS

SPRAYBERRY ACADEMY OF RADIO  
F. L. Sprayberry, Pres.  
Box 500TK  
Pueblo, Colorado

Please rush my FREE copies of "HOW TO MAKE MONEY IN RADIO, ELECTRONICS and TELEVISION," and "HOW TO READ RADIO DIAGRAMS and SYMBOLS."

Name ..... Age.....

Address .....

City ..... State.....

Tear off this coupon, mail in envelope or paste on penny postcard.



## CAMERAMAN TRACKS DOWN A TRADITION

Come war or high water, there is one tradition in the radio industry that continues to stand the test of time! It is the traditional quality for which every Meissner product is famous. With this in mind, our roving photographer recently made another trip to Mt. Carmel, Ill., just to track down the source of this priceless

asset. Part of the answer he found in busy experimental laboratories and in superior manufacturing equipment. But most of all he found it in the skill of workers on the long assembly lines or in the care and pride revealed by every individual Meissner craftsman. Shown above is a typical Meissner production line.

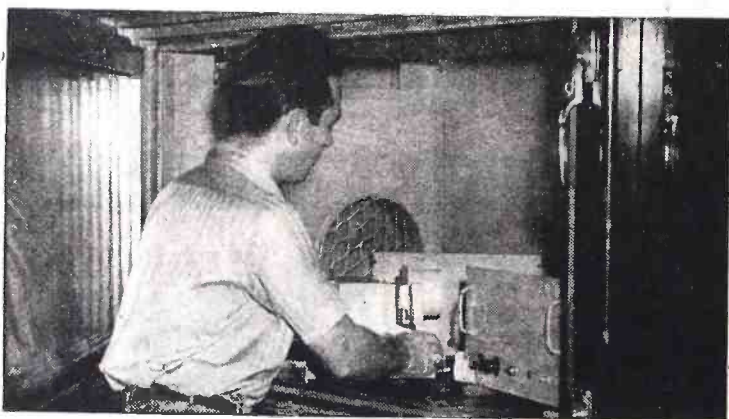

Interesting, intricate are words which might well describe some of Meissner's highly specialized equipment (above and below) but "precision-el" is the one word which fits the company's highly trained personnel.



Father and (right background) son are typical of the way Mt. Carmel families have turned to electronics for lifetime work. Meissner is Mt. Carmel's leading industry.



# MEISSNER

MANUFACTURING COMPANY • MT. CARMEL, ILL.

**ADVANCED ELECTRONIC RESEARCH AND MANUFACTURE**

(Export Division: 25 Warren Street, New York; cable, Simontrice, New York)



**PREPARE  
NOW!  
FOR A BETTER  
FUTURE**

**GET INTO**

# **RADIO ELECTRONICS**

**LEARN AT HOME  
DEFOREST'S A-B-C WAY**

This message is addressed to you men who are alert to *both today's* needs and *tomorrow's* opportunities for good jobs, good pay, and a wide variety of employment possibilities in the **BILLION DOLLAR RADIO-ELECTRONICS INDUSTRY**. Write today for **DEFOREST'S BIG, FREE, ILLUSTRATED BOOK, "VICTORY FOR YOU"**. See how you may prepare quickly, easily—in your spare time at home—to make your start toward an interesting and profitable Radio-Electronics future.

**YOU GET DEFOREST'S 3-WAY COMBINATION TRAINING—**

a simple A-B-C course of instruction—an exclusive, 3-way combination of illustrated Text, Movie Training Films, and actual Shop Work in your own home. You learn—by-**SEEING**—and *prove* your knowledge by **DOING**. You use (A) a genuine **DEVRY** Movie Projector and instructive Training Films to make your preparation clearer, easier. You use (B) **EIGHT** big Kits of "HOME LABORATORY" Radio Parts and Assemblies for working out 133 interesting experiments. You get (C) 90 well-illustrated Loose-Leaf Lessons, prepared under the personal direction of Dr. Lee DeForest, often called "*the Father of Radio*". And once you are trained, **DEFOREST'S EXPERIENCED EMPLOYMENT SERVICE** helps you make your start.

**"Learn-by-Seeing"  
FASTER... EASIER  
With the Aid of  
HOME  
MOVIES**

**YOU "LEARN-BY-DOING" AT HOME  
WITH THIS PRACTICAL EQUIPMENT**

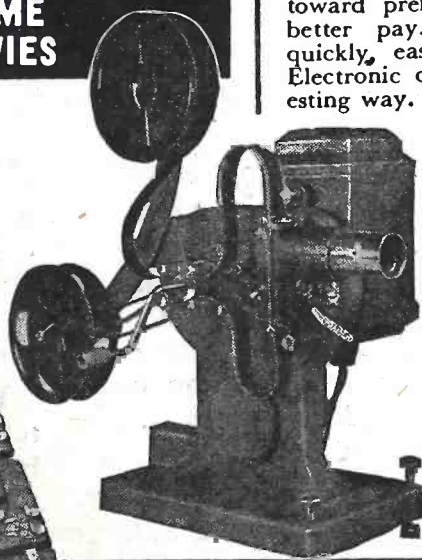
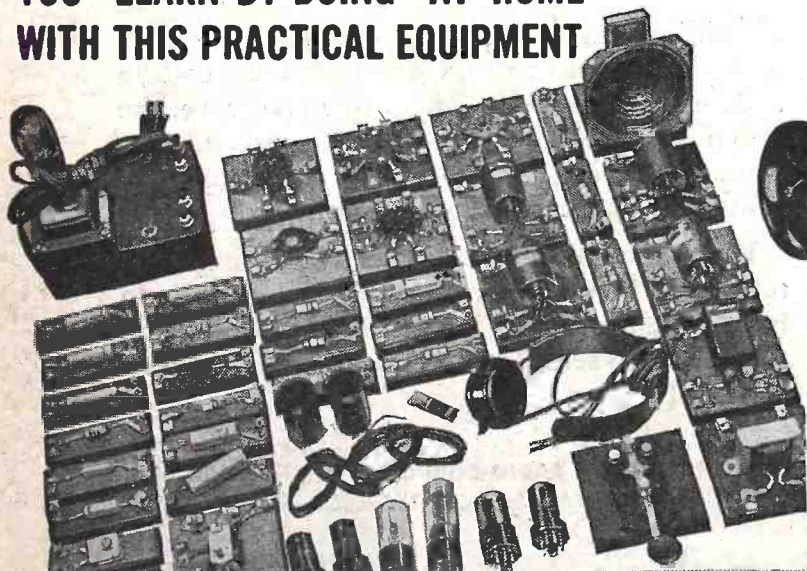

**Free! COLORFUL  
DESCRIPTIVE LITERATURE**

Simply **PRINT** your name and address neatly on the coupon below. Mail it. Get **BOTH** the colorful **KIT SUPPLEMENT** and our **BIG** illustrated book, "**VICTORY FOR YOU**". Get pages of valuable information on present and future **RADIO-ELECTRONICS** opportunities. See how effectively **DEFOREST'S** can help you—in your spare time at home—to make **YOUR** start toward a Radio-Electronics **FUTURE!**



**LET THEIR EXPERIENCE GUIDE YOU**



**Dr. Lee DeForest** supervised the Preparation of DeForest's Training.



**Dr. Norman A. DeVry** — Visual Education Pioneer — **Founded DeForest's Training.**

**DEFOREST'S  
TRAINING INC. CHICAGO 14, ILL.  
U. S. A.**

DEFOREST'S TRAINING, INC.,  
2533-41 N. Ashland Ave., Dept. RC-7  
Chicago 14, Illinois.

Send me **BOTH** your big book, "**VICTORY FOR YOU**" and your **KIT SUPPLEMENT** —showing how I may make my start in **RADIO-ELECTRONICS** your A-B-C-simple Home Training Way. **No cost! No obligation!**

Name \_\_\_\_\_ Age \_\_\_\_\_  
(Please Print)

Address \_\_\_\_\_

City \_\_\_\_\_ State \_\_\_\_\_

Check Here, if Under 16, for Special Information.



## NO SWEATER GIRLS, Please

Electronic tubes are as sensitive to lint, dust and minute particles of foreign matter, as a hay fever sufferer is to pollen. Unless the most stringent precautions are taken to keep tube parts free from impurities, trouble is sure to follow. Trouble—such as noisy receivers . . . discoloration or spots on the screen in cathode-ray tubes . . . power failure in transmitting tubes.

A model of cleanliness, is the National Union cathode spray room, pictured above. Not only clean—it's *hospital clean*. No fuzzy sweaters or lint-shedding dresses are worn here. There is no dust, no dirt, because it's air-conditioned.

Humidity and temperature are precisely controlled. The whole room is washed from ceiling to floor once a week. Then, to make sure, the individual manufactured parts are sterilized—some in boiling water—others in special solvents—still others by hydrogen firing.

Even should other factors be equal, the cleaner tube is the better tube . . . better for the public to buy . . . better for servicemen with a good name to uphold, to sell. Remember this—and *count on* National Union.

**NATIONAL UNION RADIO CORPORATION, NEWARK, N. J.**  
*Factories: Newark and Maplewood, N. J.; Lansdale and Robesonia, Pa.*



# NATIONAL UNION

## RADIO AND ELECTRONIC TUBES

*Transmitting, Cathode Ray, Receiving, Special Purpose Tubes • Condensers • Volume Controls • Photo Electric Cells • Panel Lamps • Flashlight Bulbs*

# MAKE MORE MONEY

# IN Radio TELEVISION & ELECTRONICS

**Now!**

## GET THESE 3 BOOKS

## FREE!

You men already in radio know how great the demand is for trained, experienced service men, operators and technicians. You know how fast the field is growing and how important it is to keep up with developments—FM receivers, television, electronics.

Or even if you are merely INTERESTED in radio as an amateur, you must recognize the WONDERFUL OPPORTUNITY right within your grasp to cash in on your natural talent. Make it pay dividends. Get into the EXPERT RADIO SERVICE Line. Be a TELEVISION specialist—OWN A BUSINESS OF YOUR OWN. Fill out and mail the coupon below for all the details.

Get the Latest Inside Information—  
Trade Secrets by

## SHOP-METHOD HOME TRAINING



**Learn by Doing**

Use Actual Radio Equipment  
Furnished With Your Course

Experience is the best teacher. You learn by experience with the exclusive National Shop-Method of Home Training—actually build many circuits and do experiments with the big kits of standard radio parts included in your training equipment at no extra cost to you.

In the course of your study you actually build various types of receivers—a powerful superheterodyne, a signal generator, an audio oscillator and others. You make tests and conduct experiments that show you the why and how of things. You understand what makes the various elements of electronics operate because you actually see them work for you. Not only do you gain a marvelous actual experience by this method of learning but you have valuable equipment you will use on the job in the practice of your profession as an electronics expert. Mail the coupon and learn what this means to you.



Now the famous National Schools brings its exclusive Shop-Method of training right in your own home. You can learn the most up-to-date, approved projects, systems and hook-ups step by step in your spare time. This is the sound, practical training you want and need—the development of experienced instructors working with thousands of students right in the shops and experimental laboratories of National Schools—one of the most advanced trade educational centers of the world.

This is the MODERN SYSTEM OF TRAINING. It matches the rapid progress constantly being made in radio, television and electronics. It is TIME TESTED too. National Schools has been training men for more than a third of a century. In essence this is the very same training that has helped thousands to more pay and greater opportunity.

You owe it to yourself—your future—to read the book "Radionics"—FREE to you when you send in the coupon.

**National Trained Men Now Making the Best Money in History**

The real value of National Training shows up in the quick progress our men make on the job. Joe Grunich of Lake Hlawatha, N. J., turned down a job most men would welcome. He writes: "My latest offer was \$5,800.00 as radio photo engineer, but I am doing well where I am now engaged. I am deeply indebted to National."

Ely Bergman, now on Station WOR, told us: "My salary has been boosted considerably and at the present time I am making over \$3,000.00 per year, thanks to National Training." And from the far-off Hawaiian Islands, Wallace Choi sends this: "I am averaging \$325.00 a

month. I will say that I honestly owe all this to the excellent training I had at National." National is proud of the progress graduates are making all over the world. Read about their records yourself in the books we send you FREE.

**Make Extra Money Right from the Start**

You get ahead fast with National Training. Many beginners make good money on the side fixing radios and doing service work. You can turn your knowledge into cash after the first few lessons. Progress is rapid. You can actually SEE YOURSELF GET AHEAD, because the National Shop Method is so sound and practical.

Now, right now, is the time to grasp the opportunity of today—a successful career for tomorrow. Get into the big money, rapid advancement, a position of importance. A BUSINESS OF YOUR OWN. Radio, television and the whole field of electronics invites you. The industry is crying for trained men everywhere. A rapidly expanding industry—probably the greatest in history—holds out the promise of a rich future—prosperous security.

**Train While You Are in Service**

Prepare, right now, while you are in uniform, for a glorious secure future in the field of radio and televi-

1. A complete catalog describing the industry and the extensive training facilities of National Schools.

2. You receive a sample lesson illustrating the modern "Shop Method" instruction technique.

3. The vast opportunity field of Electronics, "The Dawn of a New World," is revealed in this fully illustrated book recently published.



sion when the war is over. Make good use of your spare time by taking your National Training now. Men in our armed service, or about to enter, get better ratings and more pay almost right from the start if they are trained in radio, television and electronics. The government needs experienced men in nearly all branches of the service. Prepare for present advancement and a sound future. Learn how easy it is the National way. We are so enthusiastic because we have seen the marvelous results of National Shop Method Home Training. Send in your coupon today and see for yourself.

## NATIONAL SCHOOLS

LOS ANGELES 37, CALIFORNIA EST. 1905



### MAIL OPPORTUNITY COUPON FOR QUICK ACTION

National Schools, Dept. 10-RCR  
4000 South Figueroa Street, Los Angeles 37, California

(Mail in envelope or paste on penny post card)

Mail me FREE the three books mentioned in your ad including a sample lesson of your course. I understand no salesman will call on me.

NAME ..... AGE.....

ADDRESS .....

CITY ..... STATE .....

Include your zone number

## FREE LESSON INCLUDED

Examine the exclusive National Shop Method of Home Training. See for yourself how sound and practical it is. Be convinced that you can learn radio—electronics, television—quickly and easily in your spare time. You can't tell until you try. This trial is ABSOLUTELY FREE. And you may keep all the valuable material we send you without any obligation of any sort. Fill out the coupon immediately while you are thinking about it and drop it in the mail at once.

Thousands of men in the Army, Navy and Coast Guard have trained at National under U. S. Government sponsorship.

You are the man who must be satisfied. Mail the coupon here for the three books that tell you the complete story of the marvelous new system of training in radio electronics and television. Learn the facts of this exclusive shop-method of home training. See for yourself! DECIDE FOR YOURSELF! No salesman from National Schools will call on you.

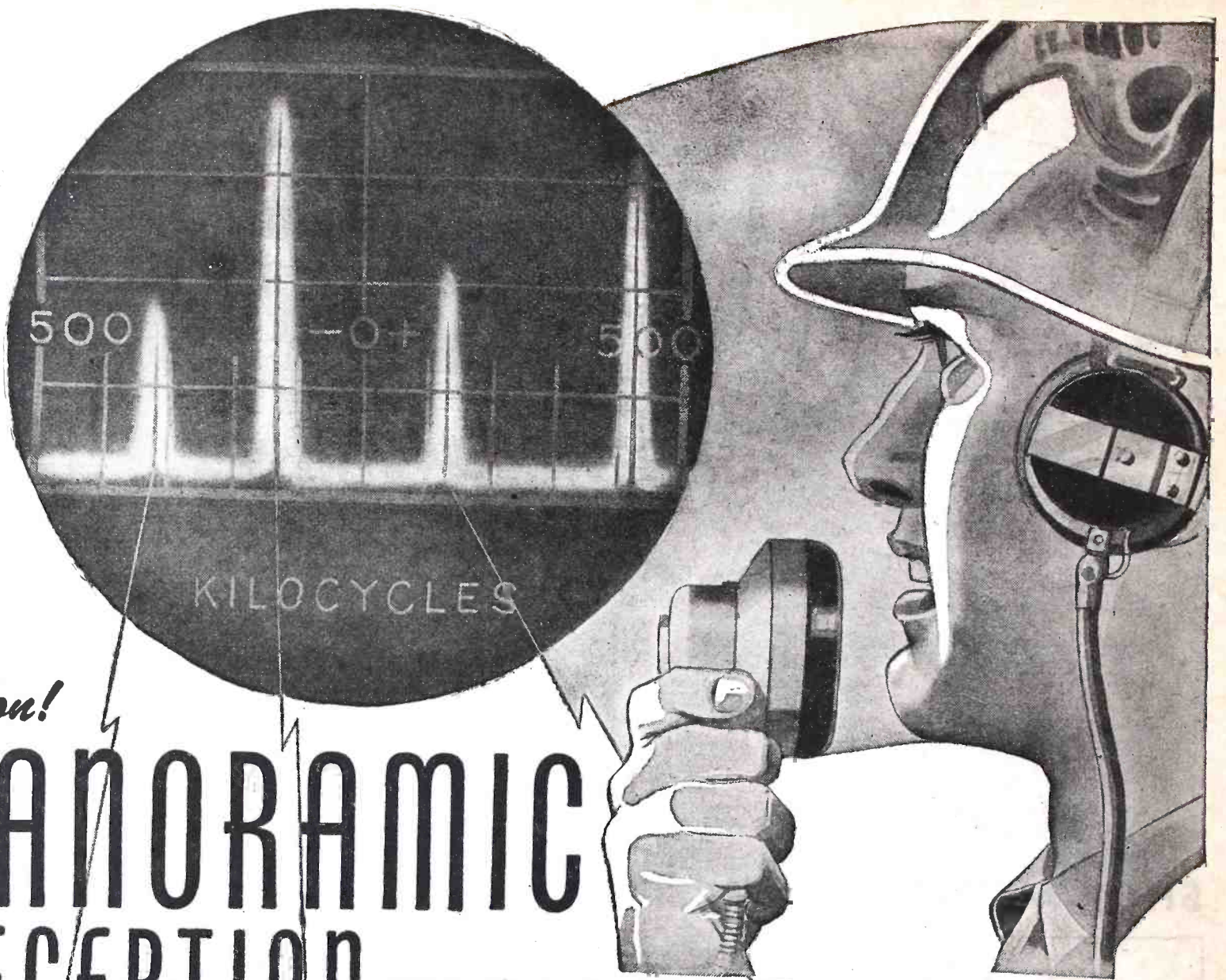

Soon!

# PANORAMIC RECEPTION

WILL BE USED BY GI JOE WITH HIS "HAM" RIG

When GI Joe takes off his helmet, he will still remember many of the things he is learning in the Army. As a radio operator, he uses **Panoramic** reception for effective monitoring and for catching tricks in enemy field communications. He recognizes its value for peacetime as well as for wartime. On the basis of military experience, he will want to make use of **Panoramic** reception for many more pleasant hours at his own rig. Because it **SHOWS ALL SIGNALS ON A GIVEN BAND OF THE RADIO FREQUENCY SPECTRUM SIMULTANEOUSLY**, GI Joe knows that **Panoramic** reception will tell him what stations are on the air, whether they are phone or CW, and what their signal strengths are when

they reach him. Most important he can be sure that he will miss very few calls in response to his CQ's.

Currently, **Panoramic** reception also is doing good work in laboratory development and industrial applications. Its ability to measure, interpret and compare variations in inductance, capacitance and resistance has created possibilities that are being utilized by far-sighted manufacturers. If

**Panoramic** technique can be adapted to your present or future needs, ask our engineers for more detailed information.



New and interesting booklet "From one Ham to another" available on request. Fully illustrated.

## PANORAMIC

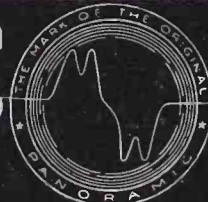

## RADIO CORPORATION

242-250 WEST 55<sup>TH</sup> ST., New York 19, N.Y.

# Radio Opportunities

. . . . The post-war period will offer more opportunities than ever before—but specialization and training will have to be above the pre-war level. . . .

HUGO GERNSBACK

**H**UGO GERNSBACK, *Editor*  
RADIO-CRAFT, New York

I recently received a disability discharge from the army. I am interested in radio and want to get back into it.

Years ago I was a subscriber to your EXPERIMENTER magazine, I have never forgotten an editorial you had in it regarding the possibilities for the individual experimenter. You stated that at that time there were numerous opportunities for the amateur with a certain amount of equipment to make tests and carry on some research and experimental work for various electrical and radio companies.

I would appreciate your opinion on the opportunities in this sort of work at the present time and in the post-war period. Also whether the cost of necessary instruments would make the work prohibitive for the average radio man.

If the present prospects are good, I would appreciate any hints you care to give me as to the best way to proceed. As I have no equipment at the present time but do have a little ready cash, I am interested in stocking up. Can you tell me if the Government or armed forces are beginning to dispose of some of the test equipment used for training purposes? If so, how could I get next to some of it?

If the above idea is not so "hot" at the present time, any leads you can give me regarding radio jobs with a good future for a man of limited training and experience but studious and ambitious would be greatly appreciated.

BLAIR R. GELBACH  
La Plata, Mo.

The above is only one of many similar letters which reach me almost daily. It is safe to say that the career interest of our servicemen who have been trained in radio is rapidly increasing as the war draws to its close,

because the thousands who have been in the service naturally feel that they wish to cash in on their radio education in the post-war world.

Twenty-five years ago, when the editorial to which our correspondent refers was written, the word "radio engineer" was hardly known. At that time we had mostly radio amateurs and radio experimenters. Today the field has enormously increased and the list of radio technicians in various activities throughout the radio art in itself becomes a most impressive catalog. Nor does the term "radio engineer" or "radio technician" alone convey any meaning, because you can be either a radio engineer or a radio technician in the broadcasting field, in television, in FM, in radio tube design and manufacturing, in radio short-wave work (including radio therapeutics), in radio receiver design and manufacturing, in pure radio research, and hundreds of others too numerous to list here.

The art of radio is tremendously complex and the words "radio" and "electronics" embrace such a vast field that even radio technicians in one radio line of endeavor have only a rudimentary knowledge of other radio branches. The field is so extensive and the promise of its future so great, that it is safe to say that every radio man worth his salt will have little difficulty in establishing himself firmly in the post-war radio world.

I am giving only two examples of what the post-war world means to radio. It is safe to say that within a few years after the war television will be a tremendous branch of radio. The new art of television itself will have many sub-divisions. There will be broadcasting, there will be television reception, there will be television receiver manufacture, and dozens of others, when this art gets under way. Tens of thousands of technical radio personnel will be required in television alone.

The second example is FM, which may be even huger than television. Thousands of FM stations will be erected until the entire land is dotted with them. Again an entirely different type of (Continued on page 45)

## Radio Thirty-Five Years Ago

In Gernsback Publications

FROM the October, 1909, issue of MODERN ELECTRICS:

An American Combined Wireless Telephone and Telegraph Service, by *Frank C. Perkins*.

Open or Closed Core Transformers? by *A. Press*.

A "Pocket Wireless."

Construction of a Rotary Variable Condenser, by *Bernadotte Anderson*.

Induction Coil Flame Arc Interrupter, by *Frank C. Perkins*.

A (Wireless) Lecture Set, by *Burt K. Bunch*.

HUGO GERNSBACK	
Founder	
Modern Electrics	1908
Electrical Experimenter	1913
Radio News	1919
Science & Invention	1920
Radio-Craft	1929
Short-Wave Craft	1930
Wireless Association of America	1908

Thermo Battery as Substitute for Potentiometer and Battery in Wireless Work, by *G. B. Sayer*.

Wireless Telephone in the Navy, by *Frank C. Perkins*.

Some of the larger libraries in the country still have copies of Modern Electrics on file for interested readers.

Wireless Stations About New York (No. 3—Station at 42 Broadway).

Torpedo Run by Wireless.

The Automatic Operator, by *O. A. Shann*.

Sounder Circuit.

Improved Electrolytic Detector.

New Method for Producing High Frequency Oscillations.

New Method for Influencing Emitted Waves.

New Spark Gap.

New Wireless Station in Spain, by the *Paris Correspondent*.

**A**N ELECTRONIC device which can measure speed of shells to .00001 second was announced last month by Dr. Philip C. Michel of the General Electric's engineering laboratory. A special magnetized shell is used for the test. It is fired through a series of coils spaced 100 feet apart and the resultant electric impulses are recorded.

Details of the instrument are not revealed, but it is known that it uses more than 100 electron tubes and that the time taken for the shell to pass from coil to coil is automatically typed in tabulated columns on an electric typewriter.

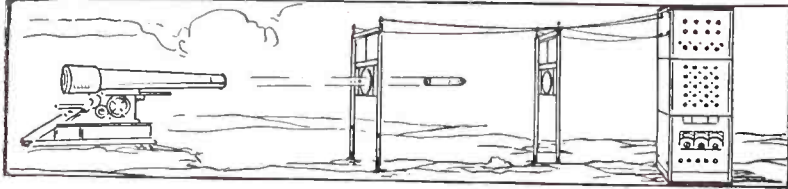

**R**AILROAD RADIO has become important enough to warrant special hearings before the Federal Communications Commission. These began September 13, and were for the purpose of developing information which might be of assistance and guidance to all parties in carrying out their further programs on the use of radio on railroads.

According to James Lawrence Fly, Commission chairman, the present investigations may herald a new era of railroad safety and efficiency. "The fact that today radio traffic control methods are used in directing the movement of railroad cars carrying high explosives is proof of the safety of the method," he declared. "It is said that an engineer in a radio-equipped engine can do in three minutes with radio what he would otherwise take 15 or 20 minutes to do. In the event of derailment or other emergency, train crewmen would be able to carry on two-way communication with a central point. It is

The shell-speed indicator. Its operation may be more clearly understood from the drawing. In effect, it is simply a time-interval meter, which indicates the elapsed time between the shell's passing the first coil and the second.

possible that many terrible railroad accidents could have been averted if radio equipment had been available."

Radio equipment, according to Mr. Fly, would supplement existing telephone and telegraph equipment rather than attempt to replace it.

It was pointed out that the large number of applications (more than 37 since January) are all for two-way radio equipment, and do not include carrier-current or wired-wireless systems in which a radio-frequency current is transmitted through the rails or other metallic circuits adjacent to the tracks, and for which FCC licenses are not necessary. The applications now before the FCC cover two-way radio communications between the dispatcher and trains in motion, between trains and between the head-end and rear-end of each train. Use of handie-

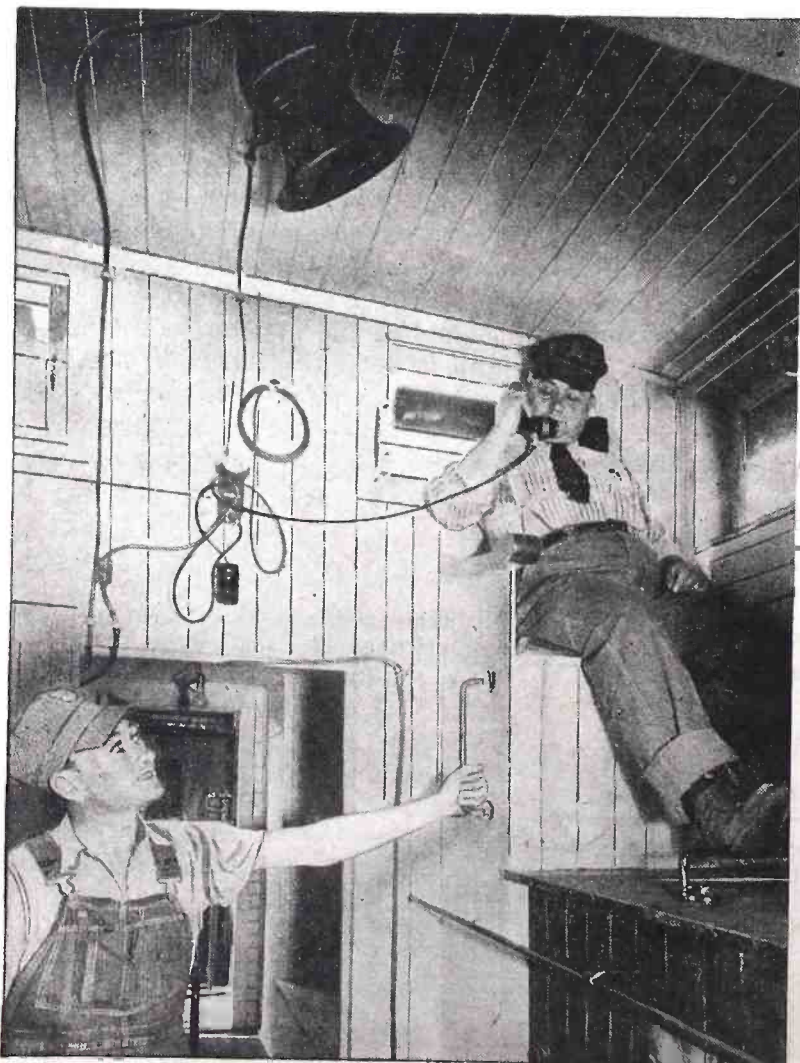

High-frequency installation from locomotive to caboose on a Seaboard Air Line train running from Richmond to Miami. Equipment, developed by Bendix, consists of two multi-channel radios, each one comprising transmitter, receiver and power pack in a compact case.

# Radio-Electronics

## Items Interesting

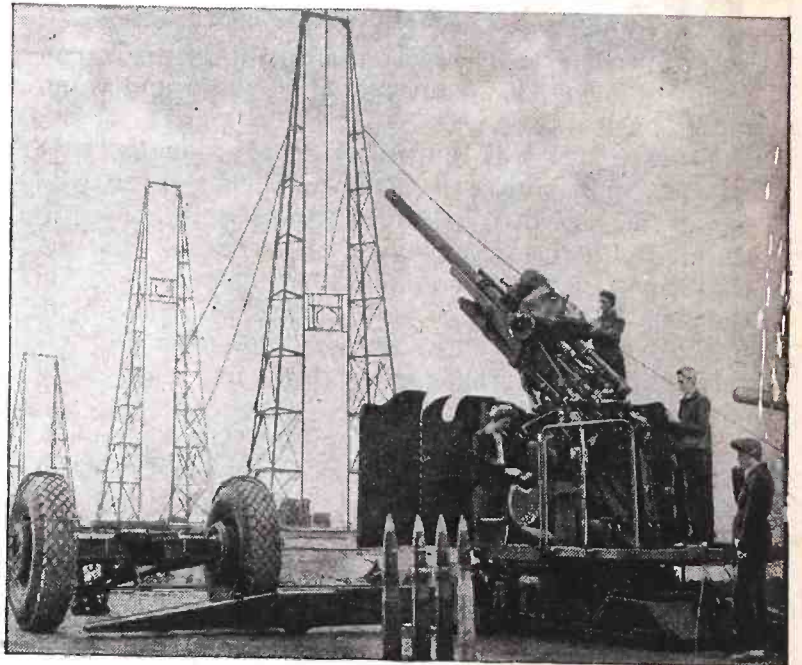

talkies by flagmen and brakemen has also been considered.

FM may find an important place in railroad work, as it is not affected by high interference levels in Diesel-electric locomotives. Even radar may be used in the future to warn engineers of the approach of other trains. The ultimate of railroad utilization may come with extension of its facilities to passengers. "Radio could provide two-way communication from moving trains; radio and television could give travellers entertainment, thus combining a safer and speedier trip with all the comforts of a modern home," predicted Chairman Fly.

**C**ONCERN over inordinately high prices paid for radio stations was expressed last month by Federal Communications Commission chairman J. L. Fly, in a letter to Congressional leaders asking for direction from Congress in determining whether the FCC should approve future sales in which the price was obviously inflated.

The case of WQXR in New York, which was sold to the *New York Times* for \$1,000,000, aroused great public attention, but smaller concerns have changed hands at proportionately higher prices. The sale of WJLD, Bessemer, Alabama, a 250-watt station with a replacement cost of \$12,269 and a book value (including all assets tangible and intangible) of \$14,236, for the sum of \$106,000, was quoted by Commission member Clifford J. Durr as a case in point.

It would appear, believes Durr, that the companies involved may be paying for the use of a radio channel. Should this be the case, it would be in violation of the Federal Communications Act, which specifically provides that radio channels are the property of the American public and are incapable of private ownership.

# Monthly Review

## to the Technician

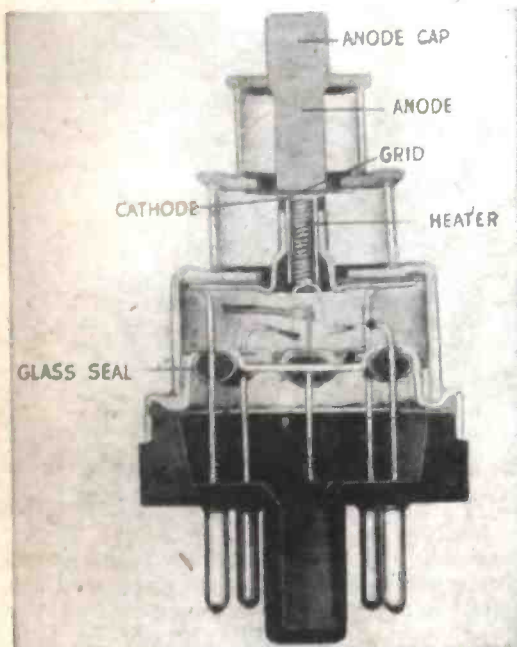

Cut-away view of the General Electric "Lighthouse" disc-seal tube. Cathode surface is on the end of the conventional cylinder around the heater.

**R**ELLEASE of further information on General Electric's new disc-seal electron tube was approved by Army and Navy authorities last month. The tube, known popularly as the "lighthouse" and to technicians as the "megatron," was known to exist, and photographs of it were even published (*Radio-Craft*, June, 1944) but no details of its construction were permitted to reach the public.

As may be seen from the accompanying photographs and drawing, instead of the elements being fitted around one another as in the (recent) past, they are constructed in simple parallel planes or layers, with glass and metal fused together in rigid, inseparable units that are strong and capable of withstanding severe jolts. This design permits an extremely compact overall tube structure, while providing plenty of power

output at extremely high frequencies. The parallel-plane construction of the new tube is the reason for the production of higher frequencies at sufficient power, and this construction is in turn dependent on the disc-seal by which the elements are firmly held in fixed relation to each other, and the necessity for long leads obviated.

Invention of the new tube advances by far the frequencies and power available for use on the ultra-highs. Just how much power or how high the frequencies cannot be revealed, by order of the military authorities. Neither may circuits nor details on applications be published.

General Electric Co. points out, however, that the new tube will permit production of efficient FM radio and television relay systems, need for the post-war networks. It will make possible for the first time the production of medium and high-power television transmitters which will be able to operate in the very high frequency bands. It will provide room for the expansion of radio navigational aids of all kinds; directional and ranging devices applicable to mobile services; numerous medical and industrial applications of electronics, and a host of other "yet to be developed" electronic products.

**R**ADIO BEAMS, aids to air and sea navigation, are now being used by German infantry to keep them on the direct line to their objective during smoke attacks, according to a last month's *Science Service* report.

The German technique was discovered through study of a captured German field manual on the use of smoke. A portable radio beam projector operated from the rear defines a path about 65 feet wide, along which Nazi signal-corps men with lightweight receivers move, guiding their comrades who do the actual fighting.

Their use of the radio beam may explain the German fondness for the use of smoke in battle, a noted feature of German strategy from the time of the Maginot Line reduction till the present.

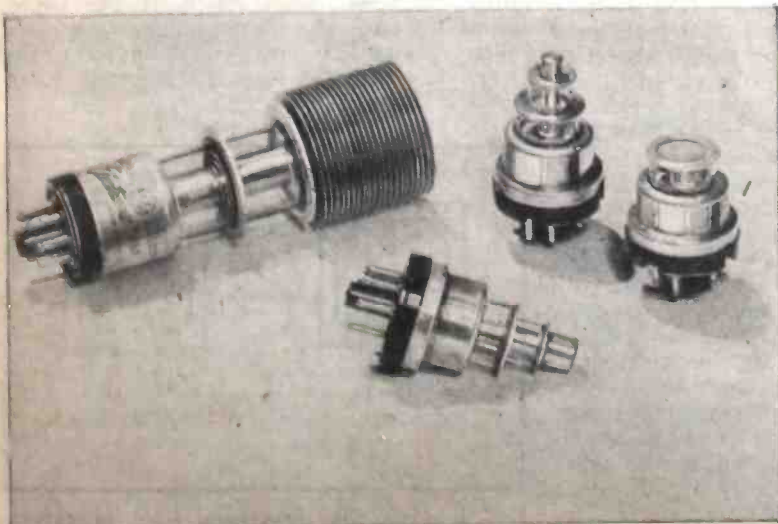

A few types of the new "Lighthouse" disc-seal tube which extends operation on the ultra-high frequencies. Tube at the left is meant to handle a rather large amount of power, as may be seen from the ventilating vanes around its top.



A recent photograph of "The Father of Radio."

**M**EXICO will have the world's first commercial television broadcasting station, if plans announced last month by Dr. Lee DeForest, father of radio, are carried through. Further, radio and television receivers manufactured in Mexico City will compete on the Central and South American markets with those of the United States and European countries.

The world-famous scientist has just returned from Mexico City, where he has been working out details of his program. According to his spokesman, John Mitchell, it is to consist of several interlocking points, most important of which are:—

1. Organization of a center for electronic research, with a capacity of 4,000 to 5,000 students, for training technicians from all Latin American countries in the various branches of radio technique.

2. Establishment of a factory to turn out radio and television equipment.

3. Founding the "world's first commercial broadcasting station" in Mexico City.

Mexico was chosen as the site of the new venture because of its central position in the Americas and because of the interruption of the peacetime output of United States manufacturers. The necessary capital—estimated at 3,000,000 pesos—will be raised in the country, and eventually practically all the necessary raw materials will also be produced inside Mexico.

DeForest, much impressed by the quality of Mexican broadcasting, which he says is better than that of the United States, "because in the latter country extreme commercialization has caused the programs to become banal and lacking in interest for many listeners," hopes to maintain the same high standards in television. "In the belligerent nations," he said, "installation of television service will be delayed. I believe it will be established in Mexico before it will be in countries scourged by the war."

**A**CTUAL production of tubes for civilian use is moving ahead at a greatly increased rate, Arthur Stringer of the NAB reported last month. According to his estimates, at least 100% and possibly 200% more civilian radio tubes will be delivered in the last half of 1944 than in the first half.

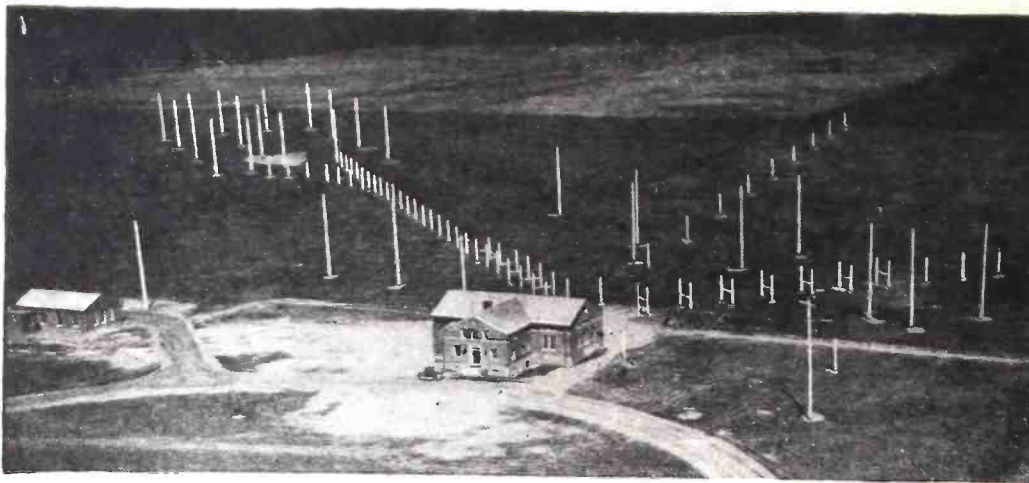

All Photographs Courtesy Federal Communications Commission

Above—Hams especially will be interested in this view of the monitoring station at Grand Island, Nebraska. Right—A small direction-finder used in locating illegal transmitters.



# ENEMY-FINDERS

The RID stopped spies before they started.

By ERIC LESLIE

**R**ADIO is the No. 1 reason for the complete failure of espionage efforts in the United States during the present war. The chief aim of enemy agents is to supply their superiors with military and naval information. The spy of today must depend on radio to forward such information—the tempo of modern war makes all other means too slow. He must flash information of movements of fast convoys—even of airplane flights—and this information must arrive instantaneously if it is to be of use to his masters.

Radio was therefore the chief means of communication of those Nazi and Japanese agents who were in the United States when the war began. But practically every time a spy turned on his transmitter, he auto-

matically surrendered to the Federal Communications Commission. So skilled is the Radio Intelligence Division of the FCC in the detection of enemy radio transmitters, that the usual first result of attempts to communicate with foreign headquarters was the arrest of the operator.

The FCC has records of cases where RID men were on the ground and had taken over before the operator had succeeded in getting in touch with his foreign contact. Another case on record is that of a group of spies on the eastern coast of the United States who were first heard by an RID direction-finding station in California. The approximate direction was furnished to other stations nearer the transmitter. They then had little trouble in tracking down the operator, whose arrest led to the capture and conviction of a ring of eight persons.

Such efficiency requires a widespread but nevertheless closely-knit organization. The Radio Intelligence Division operates 12 primary and 59 secondary monitoring stations, located throughout the United States and its territories and possessions. The primary monitors are extensive installations as will be seen from the photo above, a view of the station at Grand Island.

Located in as near ideal receiving conditions as it is possible to find, a large tract of land is devoted to directional receiving aerials. The secondary monitoring stations cannot be as well located. Each of these however, has at least one mobile direction finder, usually mounted in a car. Primary and secondary monitor are closely connected by radio and wire networks.

Two main types of locating apparatus are used. The old-fashioned loop is installed in all mobile locators and is depended on for short-distance work. Up to 50 miles it is by far the most accurate of direction-finding methods, and may be efficient with strong signals for a considerably greater distance.

The disadvantage of the loop is that it operates with the *ground wave* only. When a radio transmitter is operated, that part of the signal which spreads out horizontally parallel with the ground is the wave that is picked up by nearby aerials. At a greater distance from the transmitter, re-

ception is mostly from waves which leave the transmitting aerial at an angle and are reflected or refracted downward from the upper layers of the earth's atmosphere. This upper wave is the *sky wave*. It is this sky wave which permits distant reception of broadcast stations during the night, reflections on broadcast frequencies being much greater during darkness. During daylight the station must depend on its ground wave, and its range is greatly diminished.

The operation of a loop antenna is illustrated in Fig. 1-a. The loop is represented at right angles to the signal—as if it were moving directly into the page. During one part of the R.F. cycle currents will be set up in the loop as shown—during the other half the currents will be in the opposite direction. It will be seen that the currents in each side are in the same direction, as are the currents in the top and bottom of the loop. Since all are of equal strength, they oppose each other and no current is delivered to the external circuit.

If, however, the loop is lined up with the two sides in the direction of signal travel—as if the signal were parallel with the paper (Fig. 2-b), a radio wave strikes first one side, then travels a short distance before reaching the other. Thus current starts in one arm of the loop before the other, and the currents in these two sides are of different strengths throughout the cycle. Since the two sides do not balance out completely, some R.F. energy is delivered to the radio to which the loop is connected. Even



The Adcock apparatus, for long-distance work.

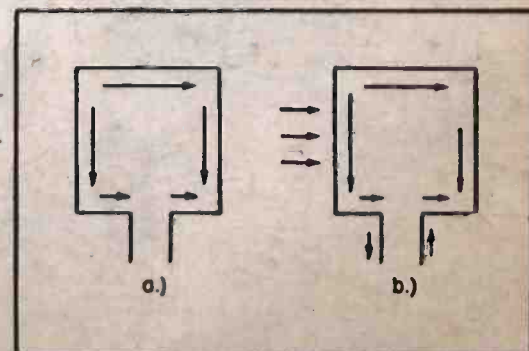

Fig. 1—How the directional loop operates.



with loops a few inches across, this unbalance between the two sides is sufficient to produce a strong response, as every owner of a portable radio knows.

To determine the direction of a transmitter, the loop is rotated to a point where the signal cannot be heard. The station must then be on a line passing through the center of the loop and making right angles to it. The "null point" or position of no signal is used in direction-finding instead of the position of greatest strength, as a very slight rotation of the loop from the position of minimum signal will give a noticeable increase in volume, whereas a rotation of several degrees from the position of maximum strength will make little difference in the audibility of the signal. Thus much sharper bearings are obtainable with the "null point."

An ordinary portable radio will indicate roughly the direction of a station, but will probably not have a point of "no signal." This is because one side of the loop is connected to the chassis of the radio, which acts as a small non-directional antenna. In a direction finder, the loop is carefully "balanced" to ground, and a sharp null point is observed. A few other adjustments and corrections must be made to compensate for any nearby masses of metal which might distort the radio wave front, in order to secure accurate bearings.

It will be noted that whether at right angles to or lined up with the signal, the effect on the top and bottom wires of the loop is the same. The same part of each radio wave passes through corresponding parts of these wires at the same time, therefore the currents set up balance each other out. When sky-waves exist, this is not true. A wave coming down from the upper atmosphere at an angle cuts the upper wire before the lower one, and the currents set up in these two wires do not balance. Thus it is often impossible to find a point to which the loop can be turned for "no signal." In the language of direction-finding, the "null point" disappears.

Under certain other conditions, a false null point widely separated from the true one may be found, and this and the true one may be tuned in at the same time, or the apparent null point may vary from one to the other. Since this occurs when sky-wave reception is strong, the term "night effect" has been applied to it, because on the frequencies formerly used by most direction-finders sky-waves are encountered only at night.

For reception over great distances, where the ground-wave has entirely disappeared and only the sky-wave is received, a different kind of direction-finder is necessary. A type in which the horizontal wires of the loop are eliminated (in actual practice replaced with doublet lead-ins which neutralize each other) is used. This is shown on the page opposite. It is known as the Adcock direction-finder, after its inventor.

The signal-collecting portion of this equipment consists of a rotating beam, approximately 20 feet long, at each end of which vertical metallic elements similar to the motor-car whip antenna are mounted. These elements are supported at their centers and interconnected by a horizontal transmission line from the midpoint of which signal energy is taken and delivered to the radio receiver. The beam is supported on a rotating shaft at its center, on top of a small hut on a tower approximately 20 feet high. The shaft goes down into the building and a handwheel on it permits turning the arms in any desired direction. The photo above is a view of the interior of the "shack."

The Adcock direction finder thus eliminates the horizontal wires of the loop, as

the two leads of the transmission line are too close together to create any difficulties. Not inherently as accurate as the loop antenna, and many times more difficult to install, it has been developed by men of the RID to a point where remarkable results have been obtained with it.

In actual practice, a single bearing obtained from one direction-finder would be useless. It would indicate the direction of the transmitter which was to be located, but could give no idea of how far away it was. If bearings can be taken from two stations spaced widely, the point where the two bearings cross is near the transmitter. Should the stations be so situated—say one to the north and the other to the west of the transmitter—that the bearing lines cross at nearly a right angle, the accuracy of the "fix" is much greater. Even a slight error in the direction of two lines at a small angle to each other makes a large difference in their point of intersection. Fig. 2 shows the position of a ship plotted from no less than eight stations.

In tracking down illegal transmitters, the procedure is to locate the approximate area from which the signals are coming, and to use mobile stations to make the "fix" within a few hundred yards. These stations may be mounted in automobiles, or may even be of the portable type shown at the head of

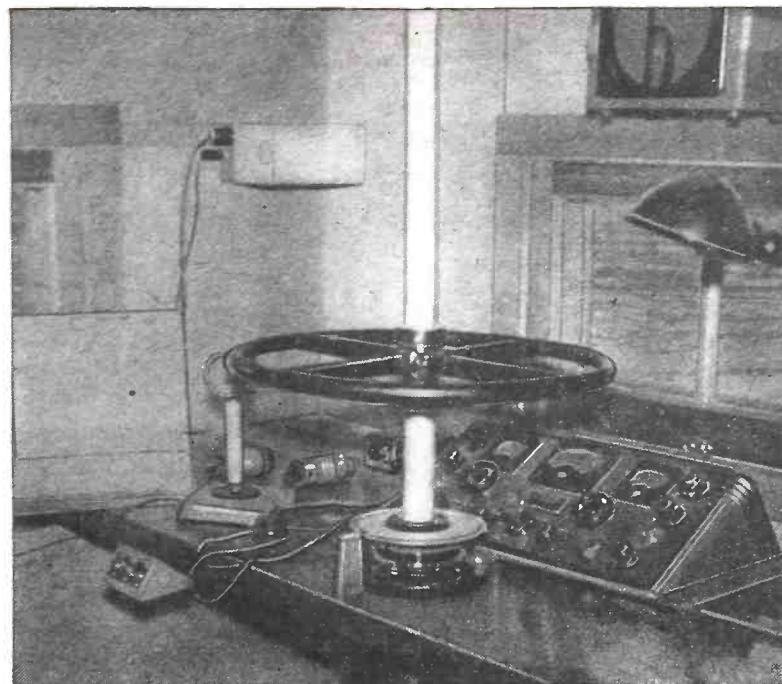

Operating position in the "shack" of the Adcock direction-finder.

the article. For even closer work—such as inside a building or within the few-hundred-yard radius—an even smaller type of receiver indicates not direction but increasing signal strength. With such a device the investigator can walk right up to the hidden transmitter.

Since July 1, 1940, the RID has discovered and closed more than 350 illegal stations. More than 400 emergency bearings furnished to lost aircraft has given the RID a life-saving record over a short time that might well be envied by the U. S. Coast Guard itself. The Adcock direction-finders will doubtless become part of a peace-time safety network when their services as spy-detectors are no longer needed. Time will tell what their end will be.

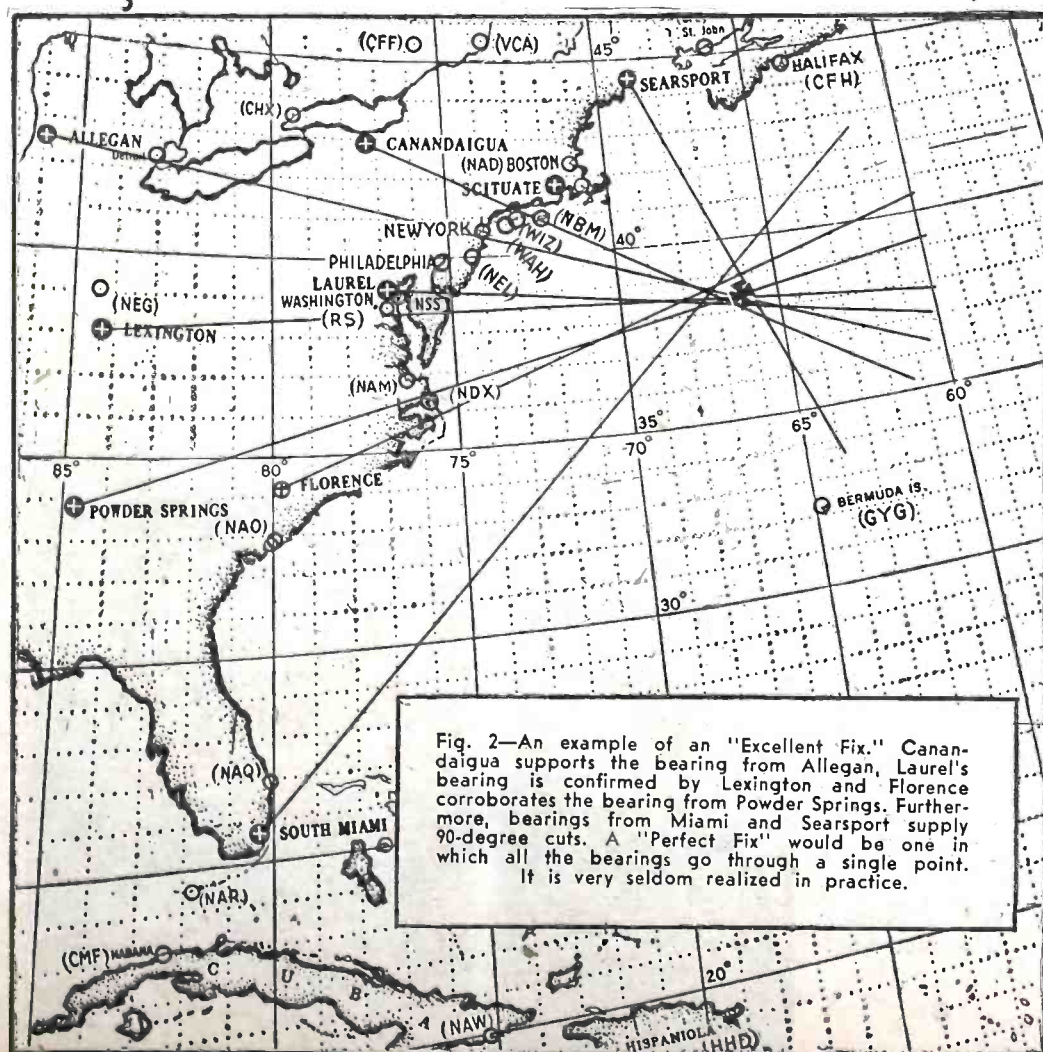

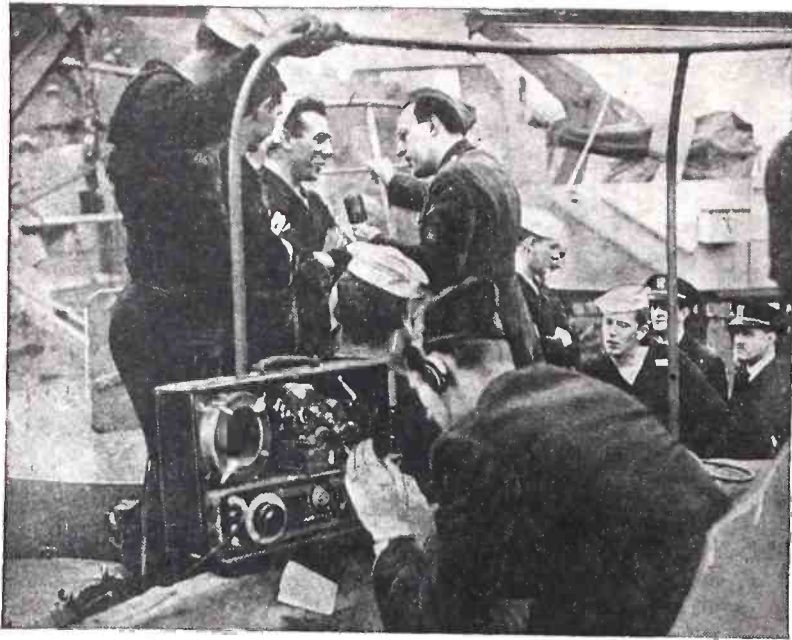

The electronic recorder in use aboard ship.



Lt. Marvin Royston of Chicago rides the gain.

COVER  
FEATURE:

# COMBAT RECORDER

"BEST of all reporters who covered the Normandy invasion," says authoritative *Time Magazine*, "was the Navy's film recorder!" The millions of Americans who listened to George Hicks' broadcast—recorded during those fateful minutes before the landing—will agree heartily. Bombs, airplane motors, big guns and anti-aircraft fire replaced the often clumsy sound effects of "dramatized news" programs. This news was not dramatized—it was the stuff of which drama is made.

That true-to-life reporting did not always

come out as expected. The sudden burst of laughter from one of the gun crews at one of the most dangerous moments was a surprise to the listener. The query of the head gunner who had just brought down his first plane was drowned out by the roars of his mates, but his "Do I get a case of Scotch?" may go down in history as one of the great speeches of the Global War.

On-the-spot film recording has in one bound become the leading form of narrative—a new art. As such, it will have its effect on conventional reporting and fiction. The writer will be compelled to revise his

colorful word-pictures of men in dangerous situations to fit the facts as known to his readers through actual reports from the scene. Where melodrama will lose, realism will gain.

The No. 1 reporter itself is shown on the cover and in the photographs on this page. Though several types are used by the Armed Forces, the one used by George Hicks and illustrated here is a film machine, the Amertype Recordgraph, Commando model. With multiple grooves side by side on each of its surfaces, it packs 12,000 feet of sound track into each one of its 50-foot rolls of film. This is sufficient for five hours of ordinary speech, though if a shortage threatened the machine could be slowed down to permit more hours of recording on the same film.

The sound is embossed by a recording head similar to that used for making phonograph records. When recorded, the film needs no further treatment or processing, but is ready for immediate playback, and can be reproduced hundreds of times without noticeable loss in quality due to wear. An interesting feature of the Recordgraph is its "vocomatic unit," an automatic voice-actuated device which starts the recording when sound signals are received.

The voice recorder is most important to the listener at home as a reporter from the battle-front. The Navy considers this a secondary use. Its really important function is to serve as an automatic log of events in the midst of battle or other emergency, when nobody has time to write reports or even to jot down the briefest notes. Often information of the greatest value in future operations can be obtained if it is known just what happened—what orders were given and what information passed on—in the heat of an engagement. The memories of persons involved are notoriously unreliable after such periods of stress are over, and it is almost the rule that a satisfactory picture cannot be pieced together from accounts of eyewitnesses taken after the event.

Another use of the Recordgraph aboard ship is to take down records of important conversations. Many valuable records can thus be made which would otherwise be impossible because of shortages of time or manpower. Not only is the machine the world's No. 1 reporter, but also an efficient "iron stenographer."

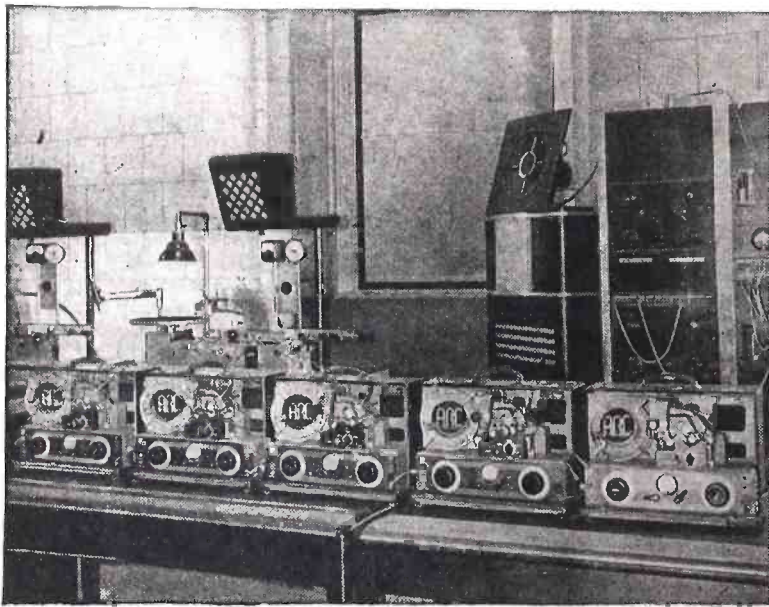

A group of the recorders as used in a large monitoring station. Several foreign broadcast stations can be checked and recorded at one time.

The Recordgraph in use by war correspondent Charles Collingwood. Gene Rider, CBS engineer, seated at left, controls the recording.



# TUBE OF THE FUTURE

## THE KLYSTRON WILL FILL MANY IMPORTANT POST-WAR U.H.F. JOBS

By CAPT. EUGENE E. SKINNER  
Hq. A.A.F. Training Aids Division

THE new fields of radio that have been developed in recent years have so changed some radio components that it is now impossible for the amateur to wind a coil, change the number and size of the plates on a condenser, and follow the latest developments. Instead, as frequencies become higher, special, critical components are required. Examples of these are found in the resonant circuits and tubes.

For the ordinary range of frequencies with which radio technicians and amateurs were concerned a few years ago, a resonant circuit could be designed to fit any frequency or band of frequencies by changing the number of turns on a coil and the size of the condensers, or by changing crystals. With an increase in frequency, fewer turns in the coils and fewer condenser plates are used. As a very high range of frequencies is reached, a single small turn of wire connecting two condenser plates must be used and crystals become so thin as to be useless. Any further variation along conventional lines is very difficult. New methods must be adopted.

In addition to the problems offered by these lumped circuit constants, as inductance of turns of coils and capacitance of plates of condensers are called, the problems of the vacuum tubes themselves become evident. These problems, caused by characteristics which were not bothersome in ordinary tubes at lower frequencies, become of major importance in the ultra-high-frequencies. In these ranges, such small quantities of capacitance and inductance are needed that the capacitance between the electrodes of the tubes and the inductance of the loops formed by the electrical circuits through which the electrons flow in the tubes are of relatively large value. In addition to this, the electrodes are of such size, distance apart, and relative position, that the time required for the electrons to travel through the tube becomes an appreciable part of a cycle. Finally a frequency is reached for each type of tube at which the starting and maintenance of steady oscillations becomes impossible. This feature is compensated for by the construction of smaller tubes of the "acorn" and other types, but the difficulties still exist above the ultra-high-frequencies, for eventually the point is reached at which the tubes are necessarily so small and possess such little power capacity as to be impractical.

One method of solving both these problems at the same time was devised by Russell and Sigurd Varian and W. W. Hansen at

Stanford University in 1937, by the invention of "Klystron"\* tubes. This type of tube embodies the principle of modulating the velocity of the electrons as they flow through it and which has at least a portion and possibly all of the oscillating circuit components included as integral parts of the tube.

The most important component of the Klystron is the resonant cavity. It is an outgrowth of the application of the lumped circuit constants in resonant circuits. When the point is reached at which a single small loop and a pair of condenser plates will no longer serve for the extremely high frequency desired, a method must be devised to apply the same principles in a different form. To decrease the inductance beyond that of a single loop, the principle that loops in parallel have less inductance than one loop is applied. Therefore, coil loops are placed between the same pair of condenser plates, until an infinite number of them have been added. See Fig. 1. The result is a doughnut-shaped ring slotted within the hole at the shortest diameter, with two plates placed parallel to the axis of the doughnut, one at each edge of the slot, so that it appears to a casual observer to be only a solid doughnut shaped object with a short plug in the center. If laid flat and cut as one would cut a pie, the cut edge would be like the outline of a dumbbell.

As the frequency is increased, this doughnut becomes smaller. In most Klystron tubes two of these resonant cavities are used, one as the "buncher" and one as the "catcher." It is obvious that an electron stream cannot pass through the solid plates in the centers of these cavities. These plates are therefore replaced by meshes or grids. In actual applications, the cavities are not always tubular doughnut in shape, but more often have distorted variations.

The action of the tube may be understood by referring to Fig. 2. A stream of electrons is beamed by a cathode through focusing electrodes and an accelerator grid toward the pair of buncher grids through which the stream must pass. The cathode and focusing electrodes have applied to them a high negative voltage with respect to the rest of the tube, which is grounded on the positive side. Voltage must necessarily be well regulated as fluctuations will affect the frequency of the tube. The buncher grids and their associated resonant cavity are excited by a radio frequency source in such a manner that as one is positively charged, the

\*Trade Mark Registered by Sperry Gyroscope Co.

other is negatively charged as in coil-and-condenser action. These grids have between them, therefore, an electrostatic field which is parallel to the flow of electrons. The strength of this field is such that it appreciably changes the velocity of the electrons, but does not do so to the point that it will stop the flow completely at any time. As an electron comes into the field, assume that it enters such a portion of the cycle as to cause it to speed up. As the radio frequency excitation passes through the zero point of the cycle, the speed of the electron is not affected. Then, as the second half of the cycle is applied, or the charges are reversed, the electrostatic field opposes the flow of the electron, slowing it down. Now it can be seen that as the excitation passes through several cycles, those electrons which have been slowed down during a cycle are overtaken by those whose speeds were not affected, and both groups are overtaken by those electrons which were sped up, causing a bunching of the electrons at a point past the "buncher" grids.

(Continued on following page)

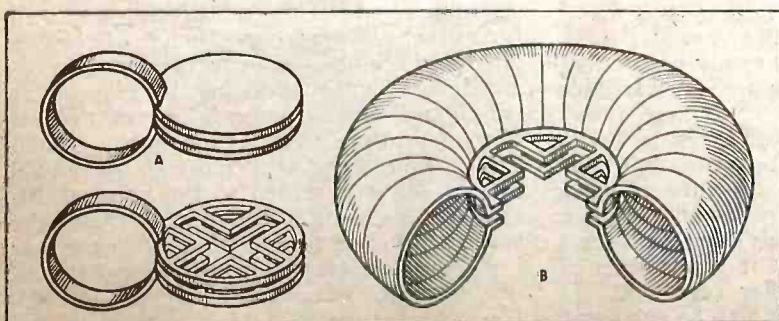
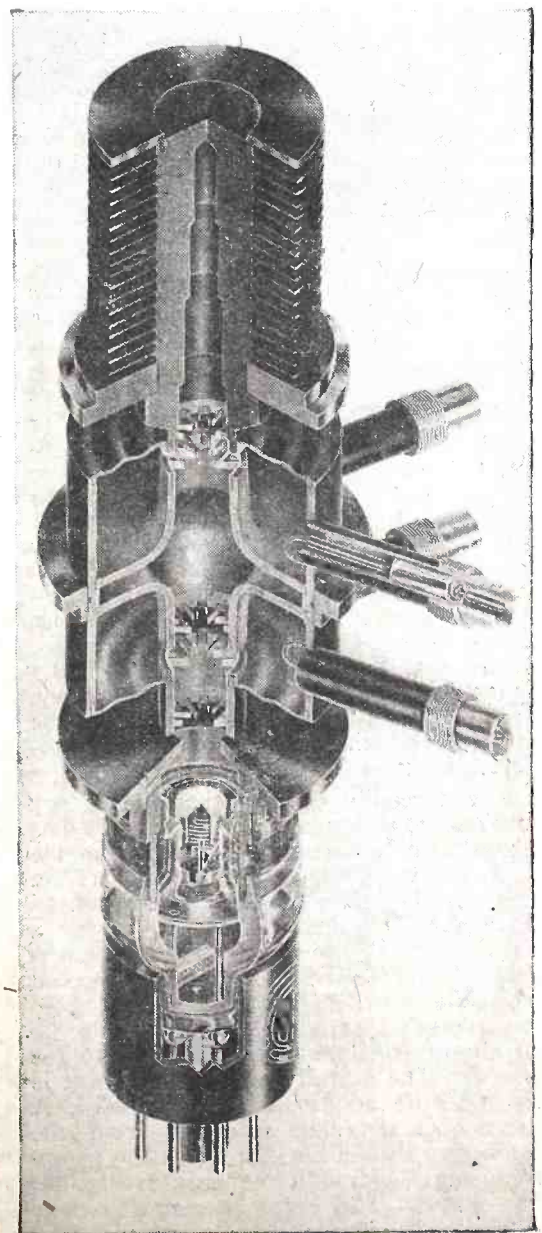
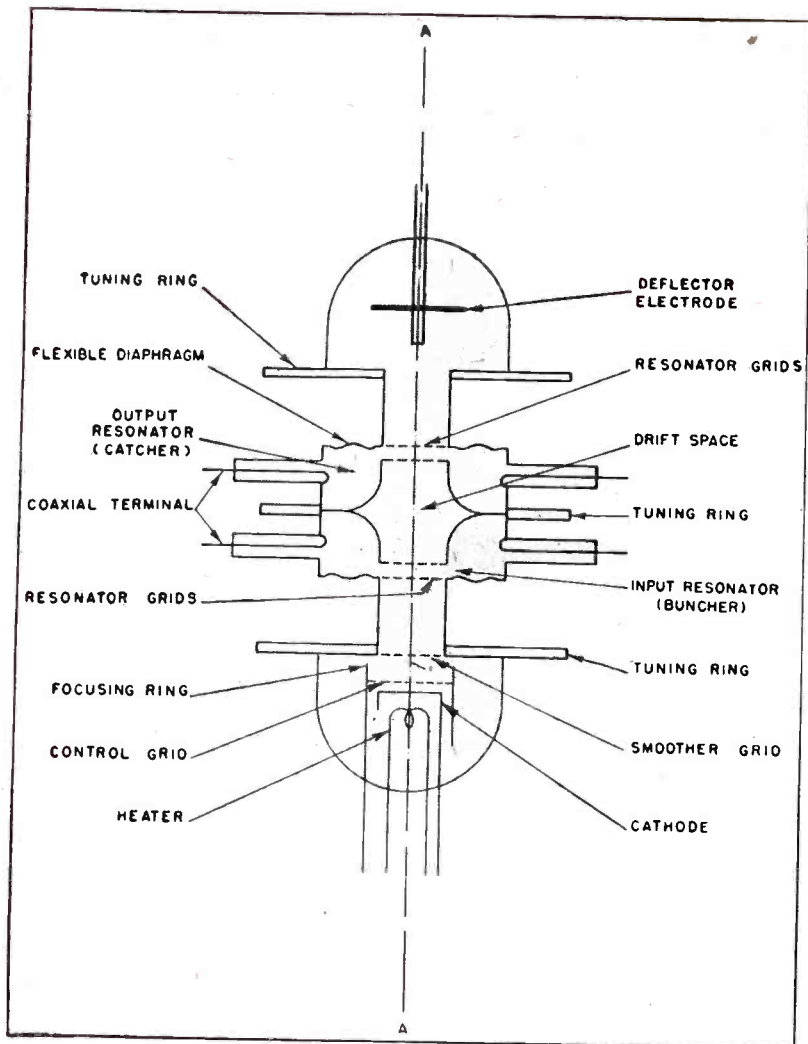

Fig. 1, left—Evolution of a resonant-cavity circuit from the coil-condenser combination may be traced with the help of this diagram. Right — Cut-away photo of a typical Klystron.

All Illustrations  
Courtesy Sperry  
Gyroscope Co.





A second pair of grids, known as the "catcher" grids, is placed in such a position that the bunched electrons pass through them at the rate of one bunch per cycle. It is assumed that the first of the grids is in the negative half cycle of an oscillation. As the electrons approach the first of these two grids, which are part of a tuned circuit, the negative charges in the electrons induce a positive charge on the first grid in a condenser-like action, then pass on toward the second grid. The original negative charge on the first grid has a slowing-down effect on the electrons, and as the energy of motion cannot be lost by the electrons without being gained elsewhere, this loss of electrons induces energy in the tuned circuit. The change of charge supports the oscillation in the tuned circuit, and by the time the bunch of electrons has reached the second catcher grid, the oscillations have changed the charge on it so that it is then negative. This negative charge, again in opposition to the charge of the electrons, still further decreases the velocity of the electrons, and, as before, this loss of energy by the electrons induces energy in this tuned circuit. After the electrons have passed the catcher grids, they are picked up on a collector plate.

It can readily be seen that the energy considerations are very important. It has been shown how energy is taken from the catcher grids while none is supplied from sources other than the electron stream. In the buncher, it is necessary to supply a source of energy to provide for the bunching, but as some of the electrons are speeded up, taking up energy from the buncher, so are some of them slowed down, giving up an almost equal amount of energy to the buncher. The overall result is that there is a very little additional energy needed. A short coaxial cable feedback from the catcher to the buncher provides the necessary source of radio-frequency oscillations and energy. The excess energy from the catcher is the output of the tube and is also

central conductor of the coaxial cables, which enter the hollow "doughnut," form a loop, and are grounded at the end. A part of the magnetic flux of the resonant cavities which exists within the hollow doughnut cavities, also passes through this loop, giving an inductive coupling which is the equivalent of an air-cored transformer.

The Klystron tubes are very versatile and have many applications. In addition to their electrical capabilities, they are reasonably rugged, lending great value under far-from-ideal combat conditions. As the frequencies increase, the tubes become smaller, the wave lengths being the controlling factor of practically all the physical dimensions. The general design is such as to provide satisfactorily for the necessary dissipation of heat.

Tuning the Klystrons may be accomplished by several different methods, depending upon their physical construction. If a tube is so constructed that the cavity is sealed within it, provision may be made whereby tuning can be accomplished by changing the spacing between the grids. Most Sperry Klystrons utilize a screw-type arrangement by which the spacing between the grids can be varied, made possible by having the grids mounted on a diaphragm which can be flexed by the screw control. See Fig. 3. This spacing is the most critical dimension as far as frequency is concerned.

If the cavity is outside the tube, tuning may be accomplished by screwing plugs into the cavity, effectively changing its volume. Several other methods of varying the dimensions of the resonant cavity or the flux inside it may be used, as well as variation of the applied voltage.

When no method of feedback is used with the Klystron tube, but a separate oscillation is used in the buncher, the tube is being applied in its simplest form as an amplifier. Since the beam of electrons gives off a great deal more energy than it absorbs, it is therefore a power amplifier (equivalent of a Class C type) and may also be used as a

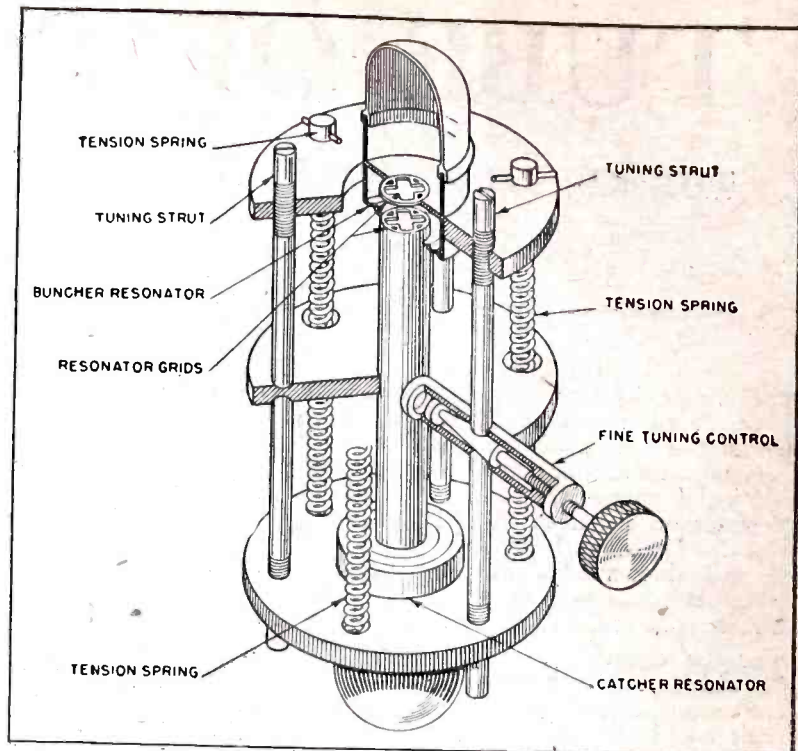

Fig. 2, left—Schematic view of the Klystron. Fig. 3, top—How the tube is tuned. Coarse adjustments are made with the three large struts, fine tuning by varying one against the other two.

taken from the resonant cavity by means of a coaxial cable. Output and the feedback is accomplished by means of one-turn loops which are formed by the

voltage amplifier for small radio-frequency voltages.

All that is necessary to convert such an amplifier into an oscillator is a method of feedback so as to sustain oscillations, and this is accomplished by means of the coaxial feed-back coupling previously described. The Klystron is generally as efficient as any other type of ultra-high-frequency oscillator. While theory indicated that efficiencies of 58% are possible, in actual practice they are considerably less.

It is very improbable that electrons would be bunched in such a manner as to produce a pure sine wave. The wave produced is actually composed of a large number of harmonics. This being the case, it is only natural that the Klystron tube should find application as a frequency multiplier. In order to accomplish this, it is necessary that the relative phase of the two resonant cavities be such that bunches of electrons hit the catcher at a time which will cause the oscillations to build up, and the catcher cavity must be designed for the desired harmonic frequency.

Unfortunately a great many of the most important applications of the Klystron tubes cannot be discussed. In the meantime, more and more applications are becoming apparent daily in the fields opened by the discovery of this important electronic device.

One thing that the war, or rather, the peace which follows it, should be able to do for radio is to clean up and set in order the wavebands assigned to broadcasting. You remember the pre-war semi-chaos which conferences, plans and much hard work on the part of the U.I.R. (Radio International Union) had failed to straighten out? The end of the war will furnish a glorious opportunity of setting all this to rights and of forming a governing body for broadcasting in Europe as enlightened and as powerful as the Federal Communications Commission in the United States. One thing that most of us would like to see is a return to the original 10-kilocycle separation between stations—the 9-Kc. separation in operation when the war broke out was not sufficient to ensure decent quality or to prevent heterodynes.—(Wireless World, July, 1944)

# Speech Amplifier Design

The theory of resistance-coupled amplifier design, high- and low-frequency considerations, transformer coupling methods, push-pull operation and tone compensation will be covered in five articles

## PART I—RESISTANCE-COUPLED AMPLIFICATION

By ROBERT F. SCOTT

THIS series of articles is an attempt to throw some light on the theory behind the operation of the lowly speech amplifier found in so many types of electronic equipment: radios, electric phonographs, public address apparatus, electronic pianos and sound-on-film projectors.

The primary purpose of such an amplifier is to properly amplify feeble electrical impulses to a value where they will be able to operate headphones, drive power amplifiers or operate metering or recording devices. This very minute voltage may be the output of a microphone, electric eye, phonograph pickup or other voltage generating device. Hence a speech amplifier is merely a voltage amplifier designed to operate properly over audio frequency ranges.

Speech amplifiers are so designed as to produce a sufficient amount of voltage amplification without distortion. In order to do this, it is necessary to select certain tubes and operating conditions as well as coupling methods to satisfy our specifications.

From our knowledge of the different classes of amplification, we realize that the Class "A" amplifier will answer our needs most effectively, for Class "A" amplifiers are able to produce high gain without introducing distortion to the extent where it will become objectionable.

### TRIODE AMPLIFICATION THEORY

Figures 1 and 2 show single stages of triode and pentode amplification. Let us consider the triode amplifier. As long as no external voltage is applied to the grid of the tube, there is a bias voltage applied to the grid by virtue of the plate current flowing through the cathode resistor,  $R_k$ . The current through this resistor will be equal to the current through the load impedance,  $Z_L$ .

Now let us apply an alternating or fluctuating voltage to the grid circuit. This will have the effect of placing the input voltage in series with the grid bias voltage. This external voltage, while ever changing, will be constantly adding to or subtracting from the bias voltage. We know that such changes in the effective bias of the tube will result in changes in the plate current of the stage.

A specific amount of amplification is available from each type of amplifier tube, when certain outside influences are neglected. This maximum value of amplification is known as the *amplification factor* of the tube. This factor is also called the *mu* of the tube, designated by the Greek symbol  $\mu$ . If we apply a signal having a magnitude of three volts to the grid circuit of a tube having a *mu* of 10, there will be available at the output of the tube an alternating voltage having a magnitude of  $3 \times 10 = 30$  volts. This voltage, which is the product of the amplification factor and the input voltage, would only be available under perfect conditions which are never quite reached in practical applications.

This circuit of Fig. 1 may be simplified to that of Fig. 3. The effect of the signal voltage,  $E_s$ , on the plate current of the tube is the same as if the plate-cathode

portions of the tube were an A.C. generator supplying a voltage equal to the product of the amplification factor and the input voltage, or  $\mu E_s$ , in series with the plate resistance,  $R_p$  and the load impedance,  $Z_L$ .

If we consider  $Z_L$  as being a pure resistor, the total plate current change in the tube will be a function of  $R_p$  and  $Z_L$  and is equal to

$$\frac{\mu E_s}{R_p + Z_L}$$

The voltage amplification, or  $G$ , available from such a circuit is equal to the quotient of the voltage across  $Z_L$  divided by the input voltage and is also equal to  $Z_L$  divided by  $Z_L + R_p$  multiplied by the amplification factor or

$$G = \frac{E_o}{E_s} = \frac{Z_L}{Z_L + R_p} \times \mu$$

By substituting imaginary values for  $Z_L$  and  $R_p$ , it will become evident that as  $Z_L$  becomes infinitely great,  $Z_L / (Z_L + R_p)$  approaches unity and the total amplification available approaches the amplification factor of the tube. Upon discovering this fact, one is likely to believe that it is possible to construct an amplifier having a gain equal to the amplification factor of the tube used. However, this would only be possible if  $Z_L$  could be made infinitely great. It is impossible, however, to construct a resistor or a transformer winding having infinite resistance or impedance. For practical purposes, it is possible to obtain a large percentage of the amplification factor of the tube. The load is set at such a value that the proper operating voltage may be applied to the

plate of the tube without using an excessive value of plate supply voltage.

The ratios,  $Z_L/R_p$ , listed below in the table show the percentage of the amplification factor which may be realized from an amplifier stage.

When $Z_L/R_p = 0.5$ ; Gain =	$.333 \times \mu$
1.0	$.500 \times \mu$
3.0	$.750 \times \mu$
5.0	$.833 \times \mu$
10.0	$.910 \times \mu$

### THE PENTODE AMPLIFIER

Unlike the triode with its relatively low plate resistance—10,000 to 91,000 ohms—the pentode amplifier tube may have a plate resistance which is often in excess of one million ohms. The load impedance in the plate circuit of a triode may have a value of two or three times the plate resistance without undue losses due to the D.C. resistance of the load. Such a load will be the controlling factor in the change of plate current and hence the output voltage.

Because of the excessively high plate resistance of the pentode amplifier tube, it is impractical to consider the pentode as being a "constant voltage generator" circuit as in Fig. 3. Let us see how we can think of it.

There is another tube factor which is constant for each particular tube type. This factor is known as "transconductance," often called "mutual conductance." Its symbol is  $G_m$  and may be expressed as the ratio of a small change of plate current, in amperes, to a small change of grid voltage

(Continued on page 48)

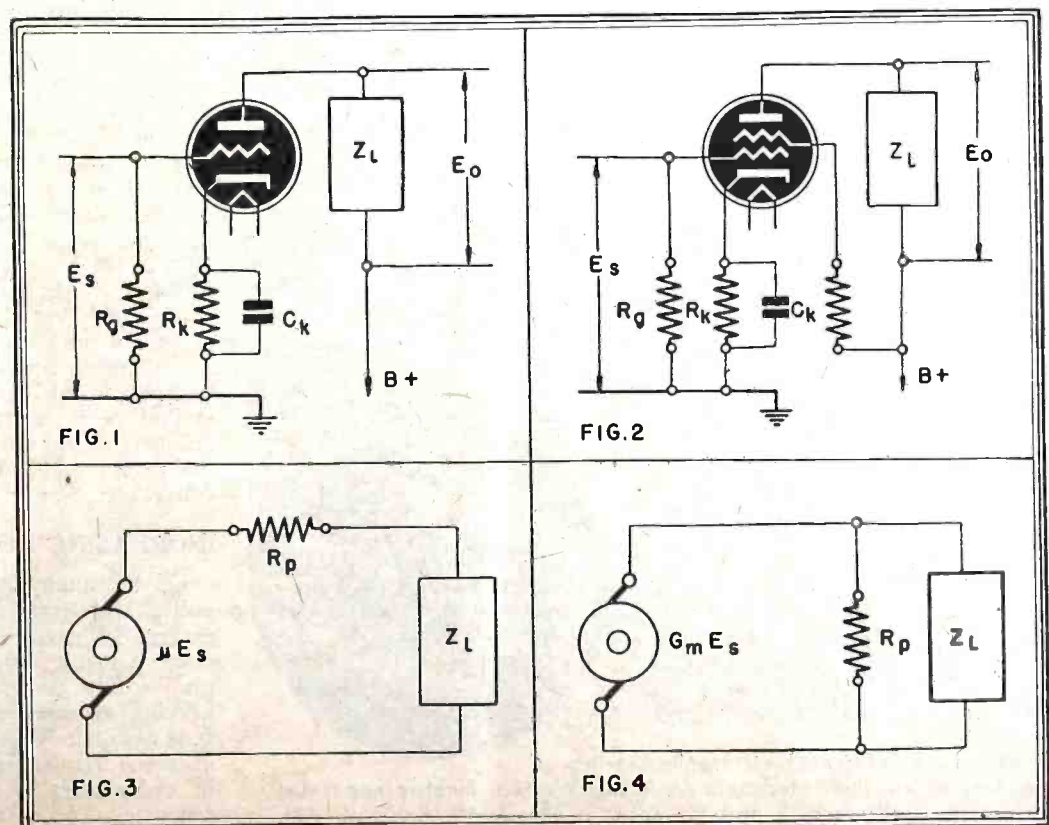

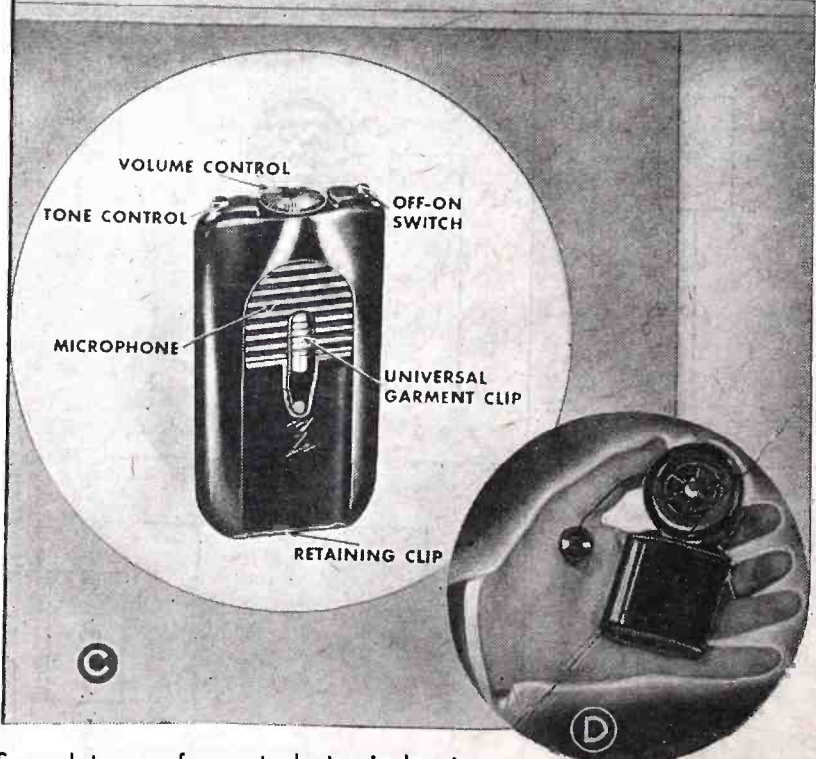
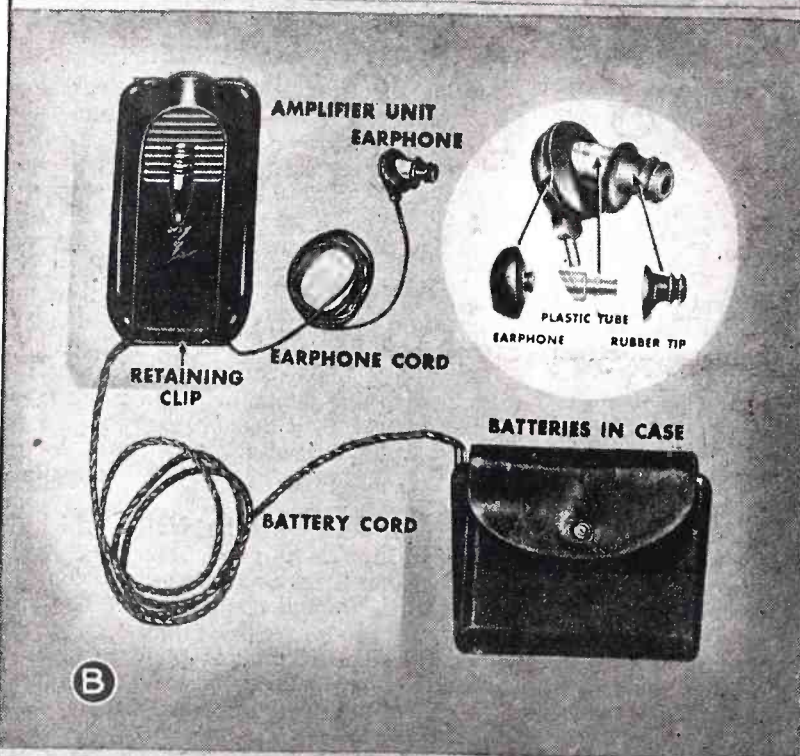
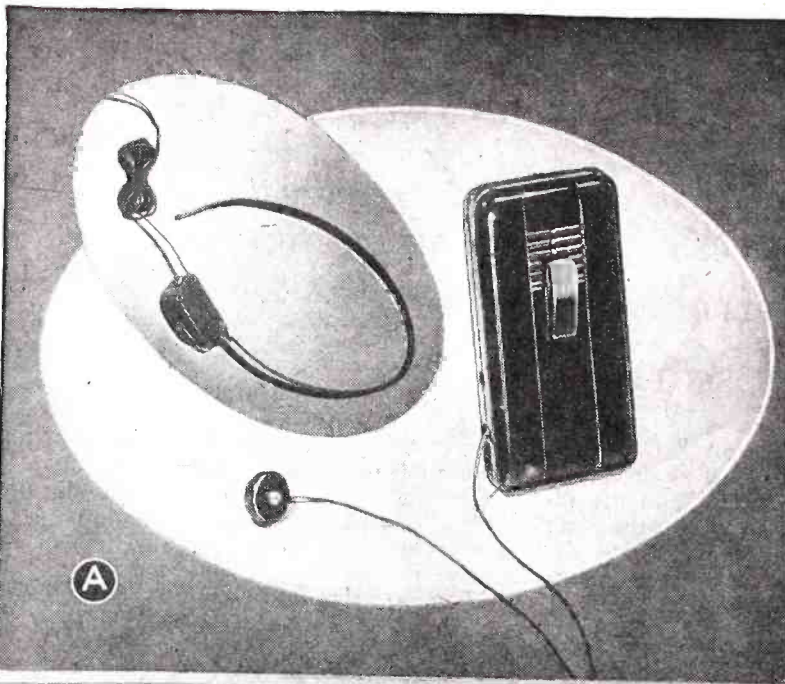

# Electronic Aids to Good Hearing

By I. QUEEN

OUR SECOND most important sense is that of hearing. A person with a deficiency of hearing misses the laughter, the music and much of the conversation of everyday life. Loss of hearing may result in loss of livelihood and even accident or loss of life. It is estimated that over 10 million people in this country, of whom about 3 million are school children, have less than normal hearing.

From hearing tests made at the Bell System Exhibit of the World's Fair in New York in 1939, the loss of hearing of a cross-section of the public is shown in Fig. 1. The reference value (0 db.) represents that of a group from 20 to 29 years of age.

To this large portion of our population not able to hear normally there will probably be added hundreds of thousands as a result of the war. A "near miss" may produce no visible physical injury yet may leave persons completely or partially deaf. The delicate mechanism of the ear tolerates only a limited air pressure without injury.

A hard-of-hearing child appears stubborn and inattentive. Several states now compel regular hearing tests to discover possible defects. Adults are more apt to discover defects and seek remedies themselves. In general deafness is incurable and seldom improves. In many cases, on the contrary, the ear mechanism becomes progressively worse with time. Some cases of deafness are due to a disease, so that a good first step is to consult a doctor or otologist.

Electronic science has developed instruments for the hard-of-hearing which may either be carried about or permanently installed as in theatres or churches. There has also been developed an instrument which in conjunction with an ordinary telephone makes it possible for the partially deaf to enjoy normal telephone conversations.

## INCREASING POPULARITY

Of the many people who require the use of a hearing aid, only a relatively small number have availed themselves of the device. In great measure this is probably due to the fact that good hearing aids are a comparatively recent development. It may safely be stated that during the few years after the war hearing aid manufacture will become a very important industry. It is also true that in the past use of the device was frowned upon in some circles. Its use is now accepted as much as the use of eye-glasses or bridge-work to correct optical or dental deficiencies. Increasing usage has all but destroyed former prejudices. It is no longer considered embarrassing or inconvenient.

Several types of recent electronic hearing-aid devices are illustrated here. A is the Western Electric apparatus with a small earpiece. B and C, views of the Zenith Radionic Aid. D, the Mears Aurophone. E is the Otariion with its battery case.

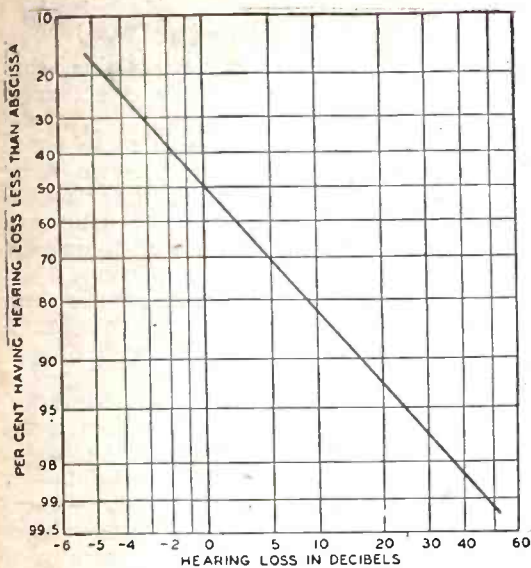
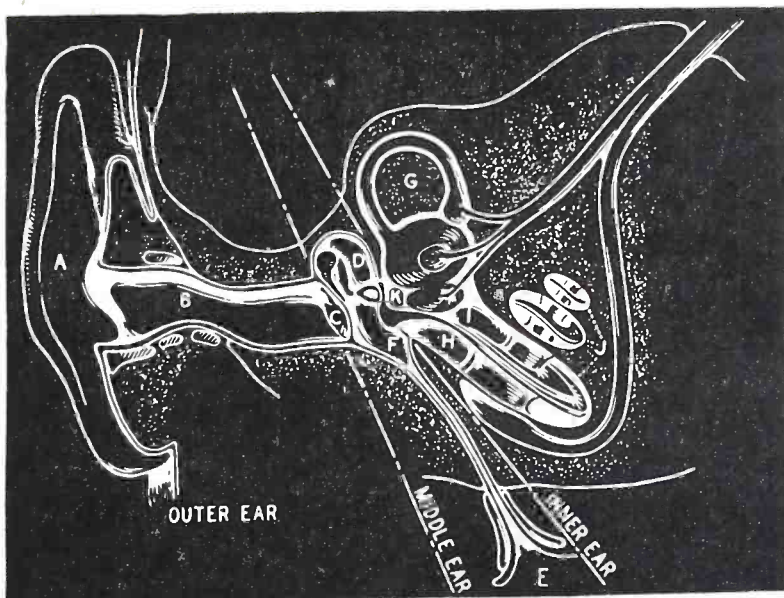

Fig. 1—Acuity of hearing differs widely, and there is no "normal" level, possessed by any significant percentage of the public. Fig. 2—The diagram at right gives a basic idea of the ear's construction and function.

Courtesy Western Electric Co.



A hard-of-hearing person is more conspicuous without a hearing aid than with one and its use enables him to carry on his business and enjoy life normally.

Fig. 2 shows how the human hearing mechanism operates. The sound passing down from the outer ear enters the canal (B) and vibrates the drum (C). Small bones contained in the drum are set into motion and in turn the membrane (K) carries the vibrations to the fluid of the inner ear (J) which is composed of two canals separated by a membrane. At this point nerve terminals convert the vibrations into electrical disturbances which are transmitted to the brain, giving the sensation of sound.

### VARIOUS DEFICIENCIES

Evidently many different types of deafness are possible. When an obstruction makes the middle ear useless, it is necessary to detour the vibrations. In such a case use must be made of a bone-conduction type of receiver. This is held securely against the mastoid bone behind whichever ear gives better results. The exact spot may make some difference. For other cases an air-conduction receiver held against the inner ear may be used. Nerve impairment requires a great deal of amplification especially at the higher frequencies. It may be found in the latter case that loud sounds of certain frequencies become so painful

that they must be limited in some way. Severe cases of deafness usually require special emphasis on the low frequencies for intelligibility.

Because of the various degrees and types of deafness, most manufacturers advise that the individual consult an otologist or ear doctor as the first step. Progressive loss of hearing is sometimes the result of a disease and a hearing aid would merely give a false sense of security and hide the real cause. Should it be discovered that a hearing aid will probably benefit the person involved, it is then usual for him to submit to a hearing test which will indicate the extent of his loss of hearing.

### WHAT IS NEEDED?

A normal ear is sensitive to frequencies in the range of approximately 16 to 18,000 cycles per second, as shown in Fig. 3. The level of minimum perception may be called 0 db. The maximum level (at which sound becomes painful) is shown by a dotted line. Fig. 3a shows how an audiogram of a partially deaf person may appear. Evidently Mr. A. has lost quite a bit of hearing especially in the high frequencies. At 1024 cycles which represents the best frequency for a normal person he has lost 60 db. of hearing. In many cases tests would show that his tolerance for loud sounds has also varied from the normal.

There are two schools of thought re-

garding the application of hearing aids. In the past it has been assumed that each individual case required extensive hearing (Continued on following page)

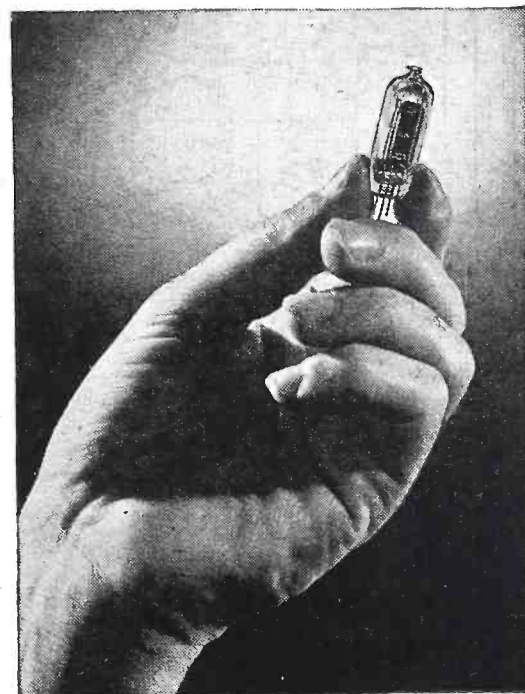

Courtesy Western Electric Co.

Fig. 4—Minute tubes are used in these units.

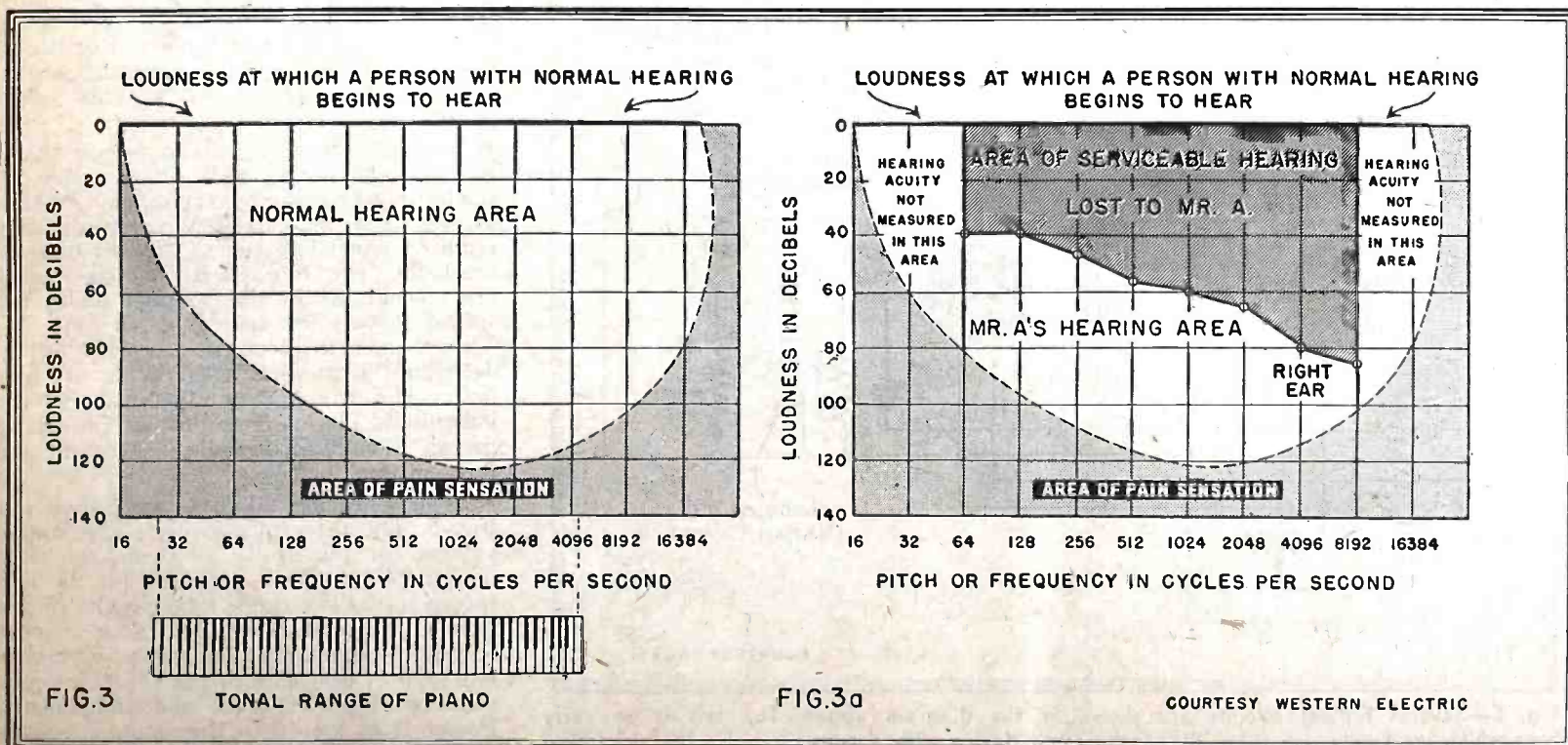

(Continued from previous page)

tests and that for proper correction, the hearing instrument must be practically custom-built or assembled. Recently, however, authorities incline towards the view that with normal tone control action it is possible to fit a great portion of the hard-of-hearing with one type of instrument. The hearing aid must have a frequency response to correct deficiencies and yet must give a minimum of interference and possible pain due to undesired frequencies. Intelligibility should be stressed rather than loudness.

A hearing instrument is conveniently made in three distinct units: the microphone plus amplifier which may be worn in a pocket or under the clothing by means of a clamp; the batteries, A and B, of miniature type, usually worn on a belt or from a strap that fits under the arm and over the shoulders, or strapped to the upper leg; the receiver, which as mentioned previously, may be of either the air-conduction or bone-conduction type. When worn by a woman the receiver is generally completely hidden by arrangement of the hair. The bone-conduction type is held by a spring band.

The microphone is usually of the carbon or crystal type and should be handled carefully, away from excessive changes of temperature or humidity. Connecting cords should be kept straight and clean to avoid fraying. The grill of the transmitter should be protected against rain and dirt. It is advisable to clean the ear-piece periodically so that no dirt or wax may form to decrease efficiency, but the receiver itself must not be tampered with. The position of the volume control depends upon the condition of the batteries, the latter being replaced when suitable volume can no longer be obtained. The B batteries usually outlast the A's. For long life, the hearing instrument should always be turned off when not in use.

Shielding is an important item in the hearing aid, otherwise interference such as from fluorescent bulbs may result.

#### BEGINNER'S DIFFICULTIES

In most cases, the new user of a hearing aid is at a disadvantage. The many new sounds seem jumbled and indistinct. It may take some time for him to become accustomed to the instrument and to enable himself to concentrate upon the desired sound to the exclusion of interference. Because of these difficulties, there is a natural tendency to become discouraged at first. This should be warned against.

As far as the serviceman is concerned, the field of hearing aids offers some obstacles, not necessarily very difficult to surmount. First, the necessary miniature parts required (including tubes) are not directly available. The tubes used in some cases are comparable in size to pilot bulbs, resulting in very low battery drain (Fig. 4). Then there is the need for a hearing test to determine just what frequencies are deficient and which may cause pain to the individual. The alert technician can easily fix up a calibrated audio instrument for this purpose, however.

Typical hearing aid circuits are shown in Fig. 5. The three-tube circuits give ample volume for practically all cases, the two-tube amplifiers being sufficient for the less severe cases. The single tube circuits shown have given good results for those afflicted only to a slight degree. For permanent installations it is desirable to use the more conventional type of tubes and components. Power from the line is then more economi-

(Continued on page 61)

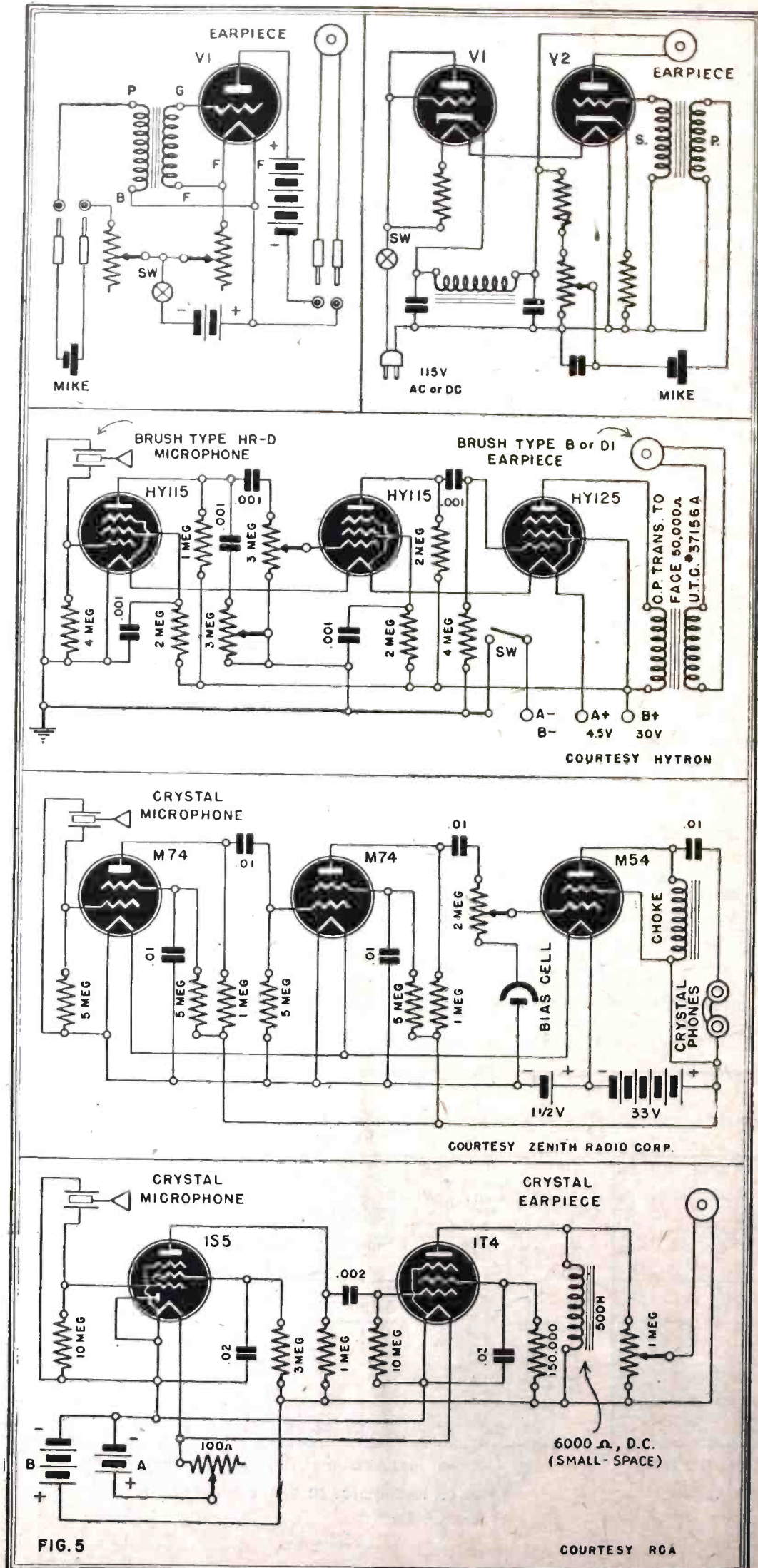

Fig. 5—Several typical circuits are shown in the diagram above. Top left is an early type which used only one tube. Right, the same device with a power supply. The set below is a modern type. A Zenith hearing-aid is shown below it, and at bottom an R.C.A. unit.



# Oscilloscopes In Industry

## PART I—THE 'SCOPE AS TROUBLE SHOOTER

By WERNER MULLER

**M**UCH has been said about the use of the Oscilloscope in the communication field. Its application for measurements has become a standard procedure. Its use has in fact become so great, that it might be considered as the one and only necessary item for visual measurement work. Without the oscilloscope today, a large part of our daily functions might well cease, since the increased burden of time required to make the same measurements with older means would indeed be enormously long.

Applications of the oscilloscope have been covered in any number of articles in various periodicals, but a summation and analysis for application in other fields of science besides communications has been lacking. With this in mind we will show a number of other applications, not so well publicized. Whatever information is available will thus be passed along and it is hoped that it will be helpful to those looking for easier methods for interpreting scientific phenomena. The listing of possible applications has been done in a group form, to permit a quick insight into the various possibilities. Each case will then be broken down into the necessary circuits and hook-ups required for observing the functions as desired.

In considering the instrument itself, a standard form of oscilloscope, as made by several manufacturers, is suggested. That is a five-inch Cathode Ray tube, with associated amplifiers capable of giving full scale deflection and having flat response characteristics from 4 to 500,000 Kc. The sweep oscillator should be able to cover from 4 to 50 Kc. The sensitivity should be high enough to permit one inch deflection with an input voltage of .03 to .05 volts. Anode operating voltage should be around 1500 to permit fine focusing. Lower anode voltages tend to give poor focusing while higher anode voltages cause loss of deflection sensitivity.

### A FEW APPLICATIONS

The following list shows a number of scientific fields, where applications of the oscilloscope are of prime value to the scientist, engineer and technician. No doubt some other fields might be included, primarily industrial application and research will be listed.

1. Electric Field. This covers manufacturers of electrical apparatus other than radio. Specifically makers of generators, motors, timers, circuit breakers, power transformers.
2. Physics. Covering research and development.
3. Mechanical Engineering.
4. Metallurgy.
5. Chemistry.
6. Aircraft.
7. Watchmaking.
8. Medical.

Each group will be discussed and a few points will be given. In the electric field an oscilloscope is a must. Let us consider a few instances where only an oscilloscope will show true values and at a quick glance.

The first application pertains to rotating power equipment, such as motors, generators, inverters and converters. Use of the oscilloscope for determining over-all performance will tell more than any other means. Brush contacts on, ring or segment type of armatures can be readily checked.

Fig. 1 shows the connection required. This will show at a glance exactly how good the contact pressure is, or should we say how even or uneven the surface is with which the brushes are contacting, or the contact surface of the brushes. If these are seen to be perfect, but other irregularities are observed, they may be traced to vibration or misalignment of the armature while in motion. Of course the output waveform—if the test is made on A.C. producing machines—can be also seen and interpreted as to its quality.

Observing these facts and compiling the data of the observations will result in a set of findings that will show good or bad performance. In production assembly this method should be of excellent use and contribute to a higher production record. Defects can be easily established before the unit is released. In A.C. machines, phase relationships can be observed and noted, corrections made when necessary. Strain and stress in the mechanical parts of the machine, due to vibration, are also determinable.

The method (see Fig. 2) used consists

of fastening a small carbon resistance (these are obtainable for this exact purpose) that has the property of changing its resistance when placed under strain or stress and thus developing a small voltage which can be amplified and seen on the scope. The  
(Continued on page 43)

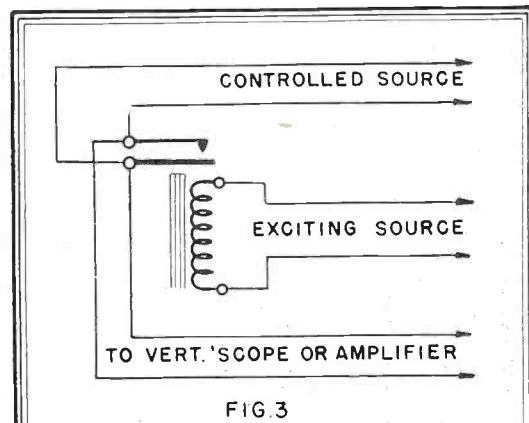
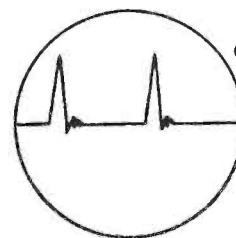

FIG. 3



PICTURE OF  
CIRCUIT ENERGY  
WHEN  
OPERATING

FIG. 4

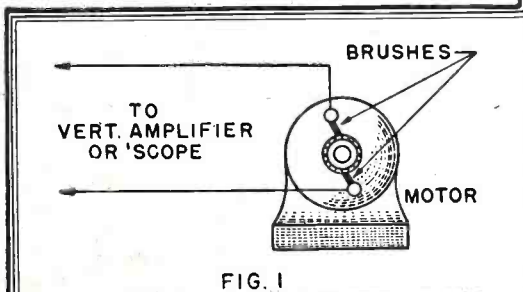

FIG. 1

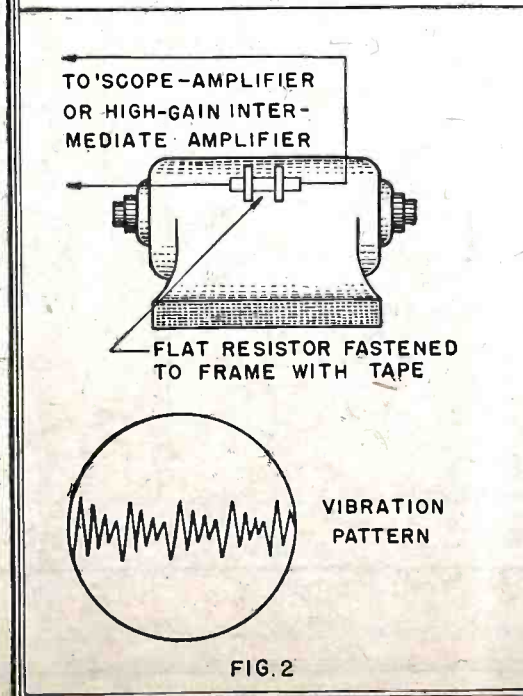

FIG. 2

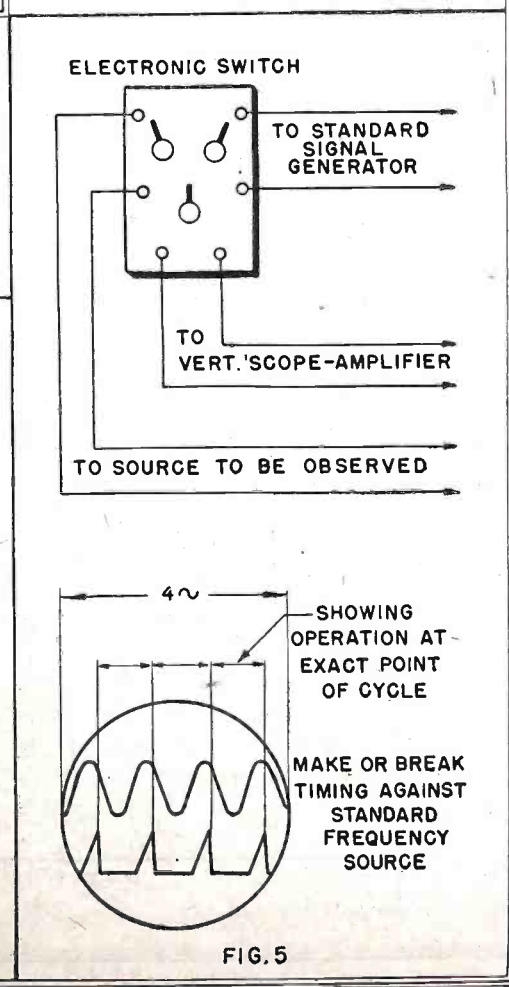
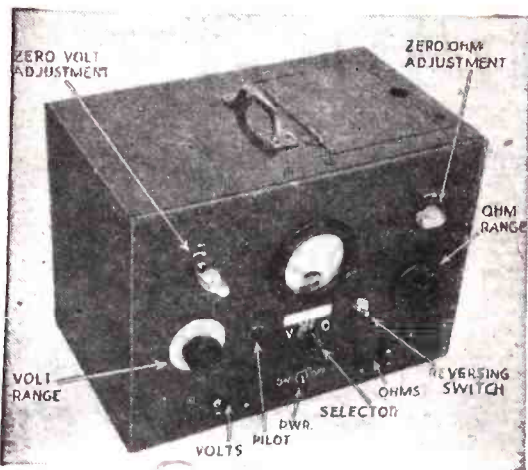

FIG. 5



The voltmeter is housed in a semi-portable cabinet. The various controls are indicated as an aid to the constructor.

**T**HIS instrument should prove of value to the busy serviceman with its ease of adjustment, its versatility and the facility with which it may be constructed. It has a voltage range up to 500 volts and an ohmmeter range to 20 megs. which will take care of most servicing.

### CONSTRUCTION

This instrument was constructed from easily obtained radio parts and no special switches, plugs, jacks, etc., were used. A chassis was used from a small broadcast receiver and the power transformer, sockets and 25,000-ohm meter control were mounted upon it. The panel is of plywood, and the

Those of our readers who possess the necessary low-range milliammeter will welcome this article. The instrument is easy to construct and measures voltage and resistance equally well

# 3-Tube Voltmeter

By JOHN F. COOLEN

meter, the various control switches and insulated tip jacks were mounted on it before it was bolted to the chassis. The range switches are the ordinary seven-point or more tap switches while the selector switch was a "Mallory" four circuit; three contacts per circuit switch. Do the wiring and soldering carefully. Many troubles can be avoided by careful soldering of all connections. The resistors used for the various ranges are of the 1/4-watt carbon type. These were found to be sufficiently accurate for this instrument. The batteries for the ohmmeter are two small flashlight cells type AA and are soldered directly to their connections with short pieces of hookup wire. Little trouble should be experienced in building and wiring as plenty of room has been provided on both the panel and chassis.

A test lead should be made from three feet of shielded wire and a 2 meg. isolating resistor placed inside the test probe, as

shown in Fig. 2. A short piece of wire is soldered to the shield just above the phone tip and is plugged into one of the instrument grounds. Another test lead terminating in a small battery clip is used to bond the set being tested with the V.T. Voltmeter's ground.

Check the wiring and place the tubes in their sockets, turn the selector switch to the off position and apply the power. Allow the instrument to warm up for a few minutes, then throw the selector switch to the "volts" position and adjust the meter to zero volts with the 3,000-ohm potentiometer. If the meter cannot be brought to zero it is usually due to mismatched tubes. Try several until a match is obtained. Throw the reversing switch to the opposite position. The meter should still read zero. If it does not, adjust it with the mechanical zero adjustment on the face of the meter and the 3,000-ohm potentiometer until it

(Continued on page 46)

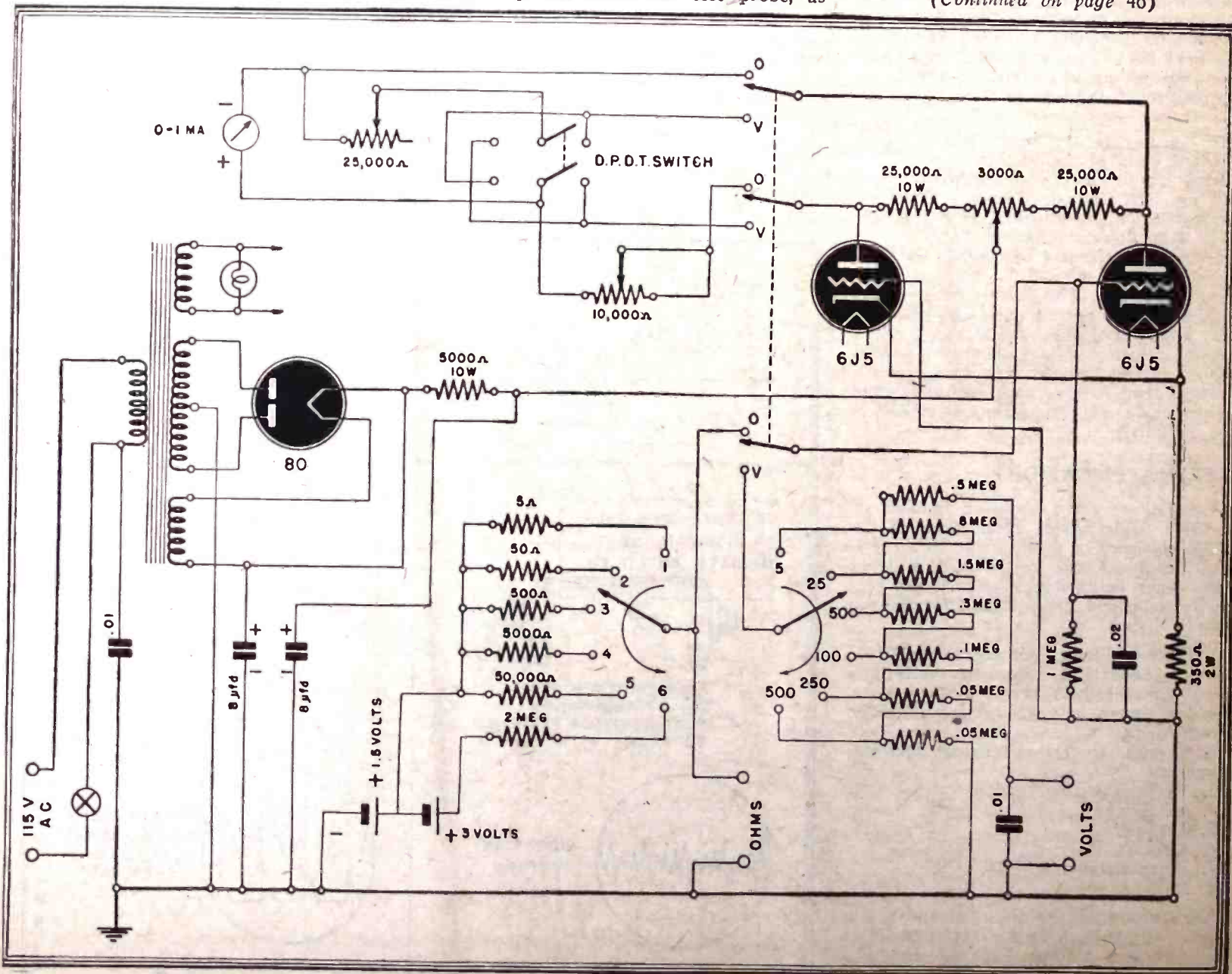

Fig. 1—Complete schematic of the 3-tube electronic voltmeter. No odd-size resistors or special parts are needed to assemble this instrument.

# BROADCAST EQUIPMENT

## PART II—MIXERS AND AMPLIFIERS

By DON C. HOEFLER

THE high-fidelity microphones used in most broadcast applications are characterized by extremely low output. As a result, audio amplifiers having a total gain of approximately 100 decibels must be inserted between the microphones and the transmitter. Usually a preliminary amplifier is placed between each microphone and the mixing system, although a single pre-amplifier may be placed following the mixers, as will be explained.

Pre-amplifiers must be designed and constructed with extreme care, for any noise originating in them will be enormously amplified by the succeeding amplifier stages. This may be understood by considering the fact that in the output of such a system any noise due to thermal agitation in the microphone leads or short effect in the first amplifier tubes is easily distinguishable. Hence, it is obvious that the usual amplifier noises such as microphonics and hum must be practically non-existent. This is accomplished in practice by the use of an extremely heavy shielding around the input transformer, quiet-heater type tubes, and a separate filament transformer, which eliminates the necessity of bringing the full A.C. supply-voltage leads close to the low-level audio circuits. In the installation of any pre-amplifier unit, very careful consideration must be given both to microphonics and to inductive coupling from stray fields. It should be mounted where the tubes are not liable to any excessive mechanical vibration, and well away from A.C. lines and power-supply systems. A typical amplifier of this type is shown in Fig. 1.

### MICROPHONE MIXERS

A mixer circuit is an arrangement of volume controls which allows the control-room engineer to combine into a common output circuit the outputs of several microphones, phonograph pick-ups, remote lines, network lines, as well as any other type of program source, each at the desired level. Since these various program sources may have widely differing impedances, it becomes necessary for the faders to perform the additional function of impedance-matching devices, in order to prevent the introduction of frequency distortion. Mixer circuits are also used for "fade-ins" and "fade-outs," to attain desired dramatic effects. The possibilities available through variation of this technique are almost endless.

There are three basic types of faders: the L-type, T-type, and H-type. From these have come several variations, including the ladder-type, which is the latest advancement in mixing controls. The L-type fader, shown in Fig. 2-A, may be used where constant-impedance requirements are not very strict, and is sometimes used as a microphone fader. The T-type, shown at B, is much more satisfactory than the L-type fader, as regards constant-impedance requirements and frequency characteristics. However, this type also has all of the series resistance in one side of the line, which causes an unbalanced condition. The H-type attenuator, shown at C, is used where the transmission circuits must be

balanced to ground. This attenuator also maintains a fairly constant impedance characteristic in both directions when prop-

erly terminated by a correct resistance. The ladder-type fader, shown at D, main-  
(Continued on following page)

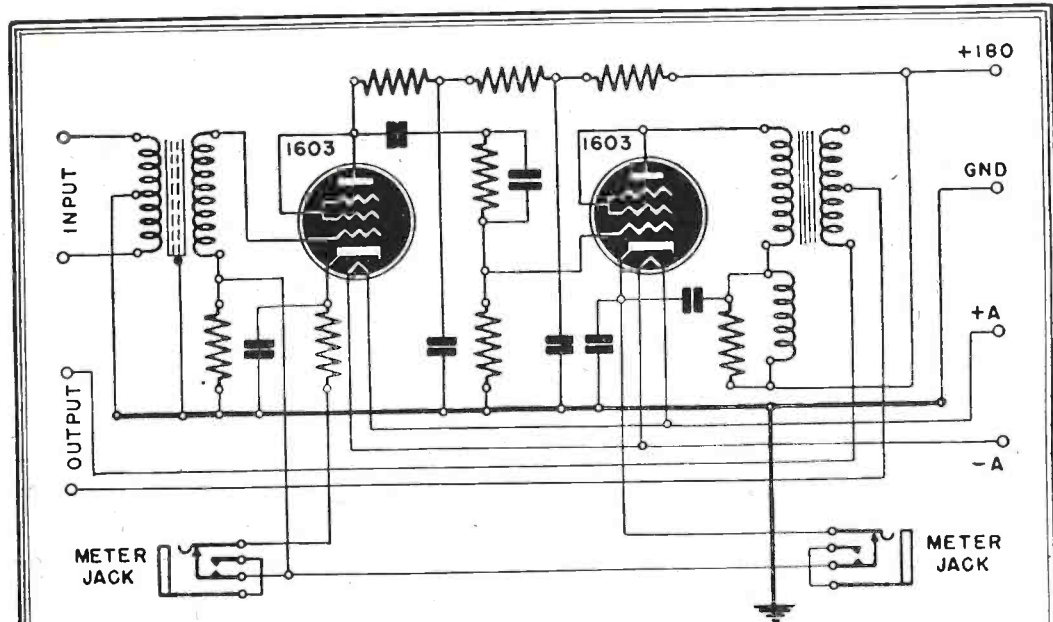

FIG. 1 RCA TYPE 41-B PRE-AMPLIFIER

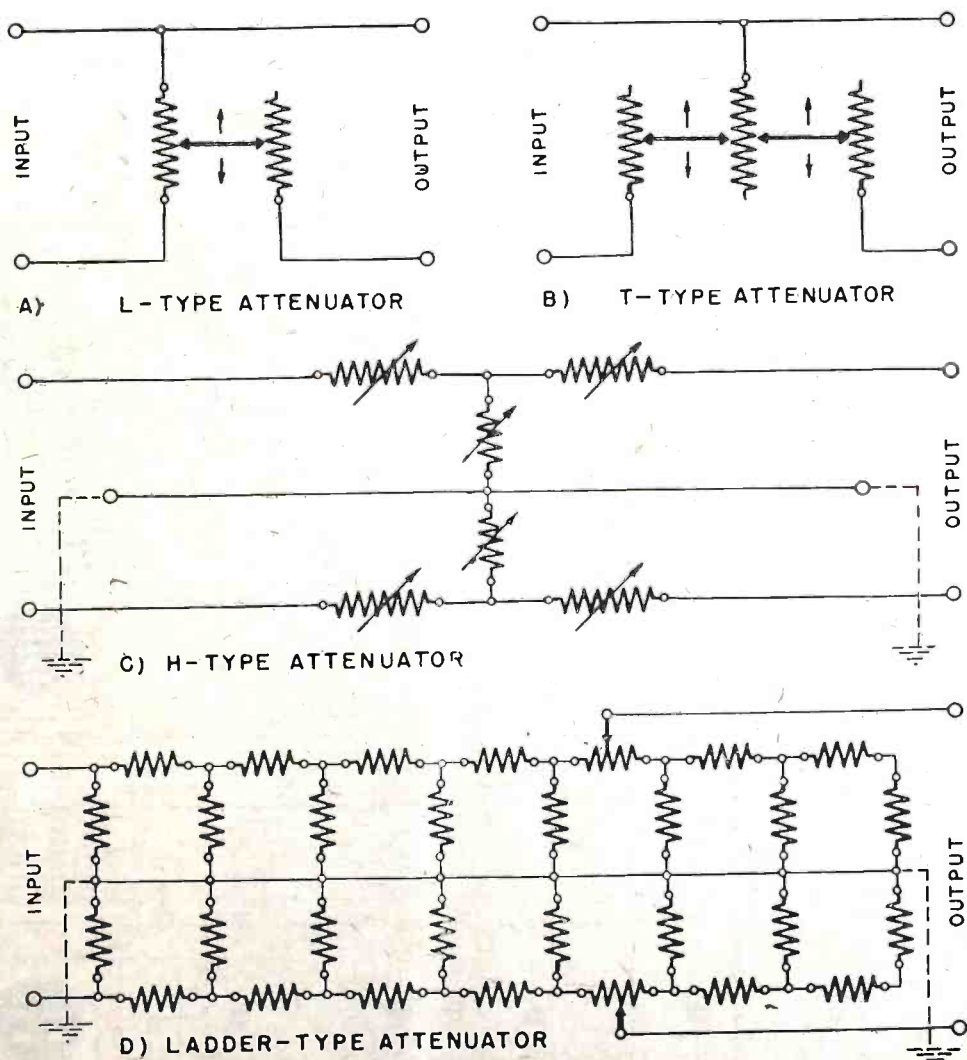
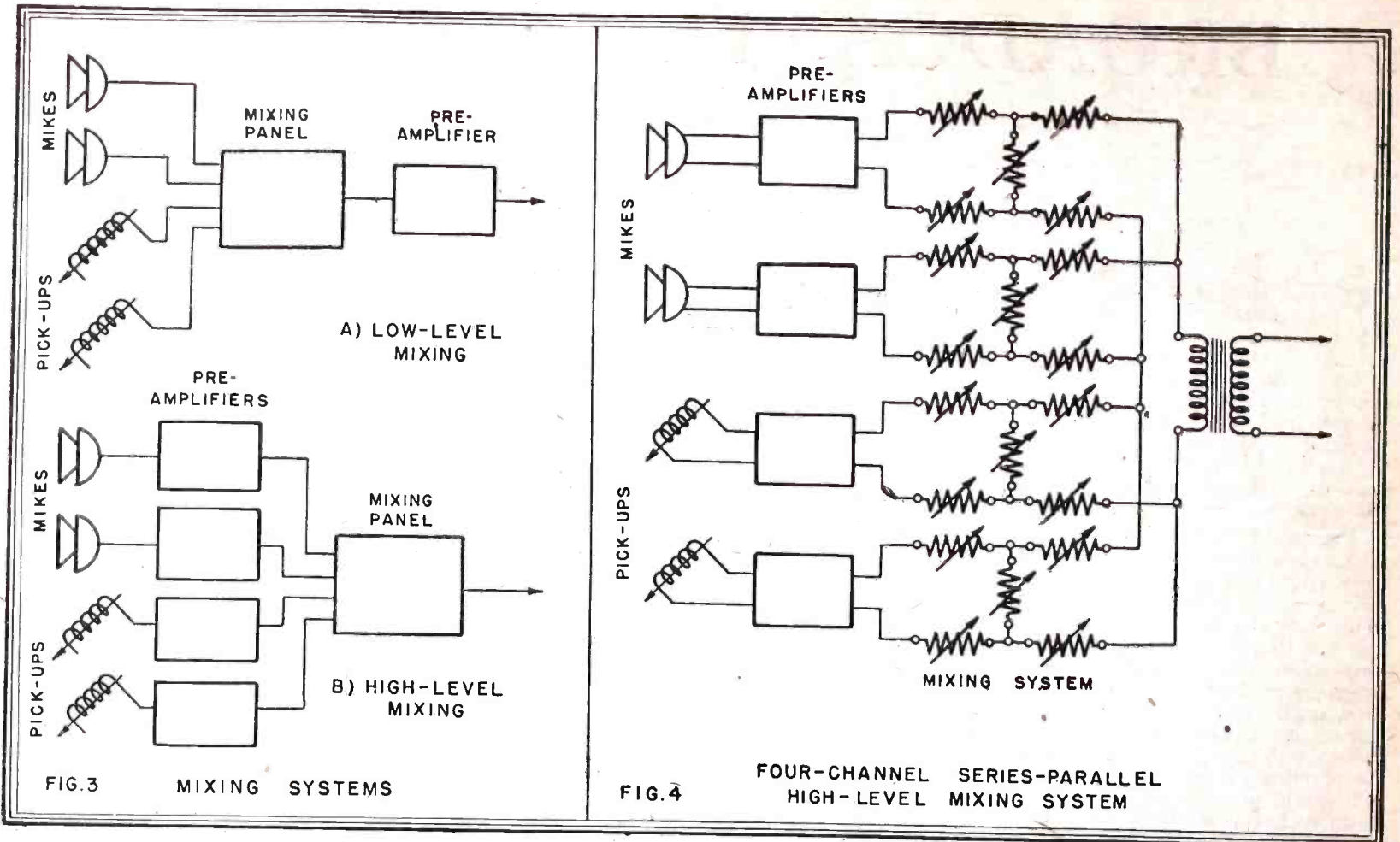

FIG. 2 VARIOUS TYPES OF FADERS



tains an impedance that remains practically constant in both directions throughout the attenuation range. The further advantages of this type are its simplicity of design and construction, requiring fewer contacts and switches. The ladder-type attenuator is used almost exclusively in modern broadcasting equipment. However, the minimum attenuation setting of a ladder pad is at a level of approximately  $-2.5$  db, which corresponds to its insertion loss (loss due to placing the control in a circuit). Where an attenuation range is required beginning at zero, the T or H structures must be used.

#### HIGH- AND LOW-LEVEL MIXING

Low-level mixing, as shown in Fig. 3-A, is characterized by the fact that the various program outputs feed directly into the mixing system before undergoing any amplification. This system is confined to low-impedance microphones, such as the velocity and dynamic types, having an output of about  $-75$  to  $-85$  db. High-level mixing, shown at B, is a system whereby the program outputs are connected to pre-amplifiers, and the mixing is accomplished following amplification, at a level of approximately  $-30$  db.

High-level mixing is more expensive, but is to be preferred in most cases, because of its inherently more favorable signal-to-noise ratio. It has been found that, even when all extraneous noise pick-up can be eliminated, the background noise will be approximately 10 db higher in a low-level mixing system than in a similar high-level mixing system.

Multi-channel mixers are generally connected in series-parallel. A typical four-channel series parallel high-level mixing system of the type used in broadcasting service is illustrated in Fig. 4.

The studio amplifier, known variously as a program amplifier or line amplifier, has as its purpose the amplification of the outputs of microphones, phonograph pick-ups, or other program sources or their associated pre-amplifiers. It must raise the program level to one suitable to be applied to the master control-room program amplifier, or directly to the program line or modulator. Since this equipment must necessarily be of the high-fidelity type, many low-distortion features are incorporated in its design, such as triode-connected tubes, resistance coupling between stages, push-pull output, etc. A shock-mount installation should be provided, and the unit should be placed so that magnetic coupling with any other amplifier input circuit is avoided. Otherwise excessive hum may result. A typical amplifier of this type is shown in Fig. 5.

(Continued on page 47)

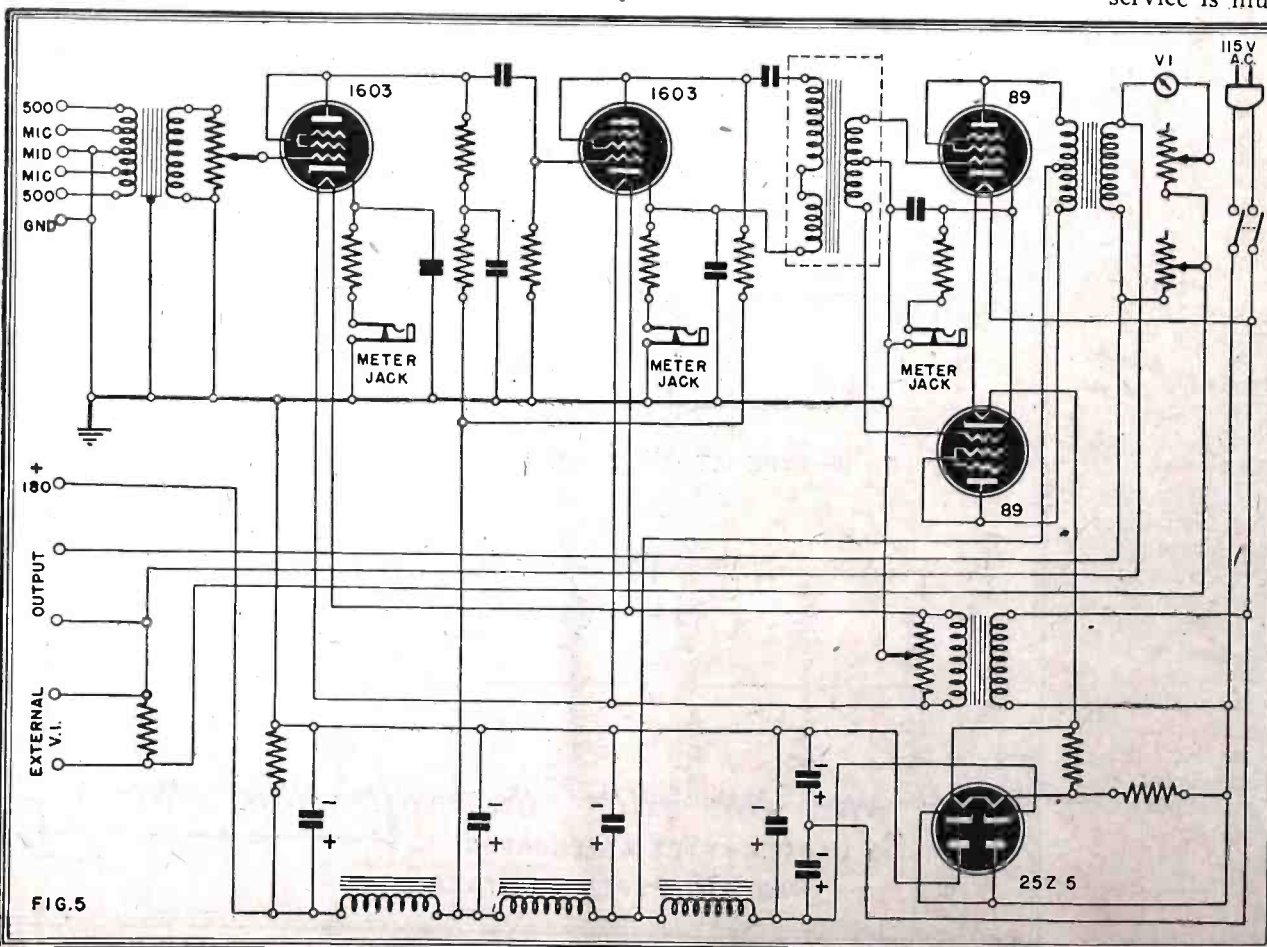

# ELECTRONICS AND AIR POWER

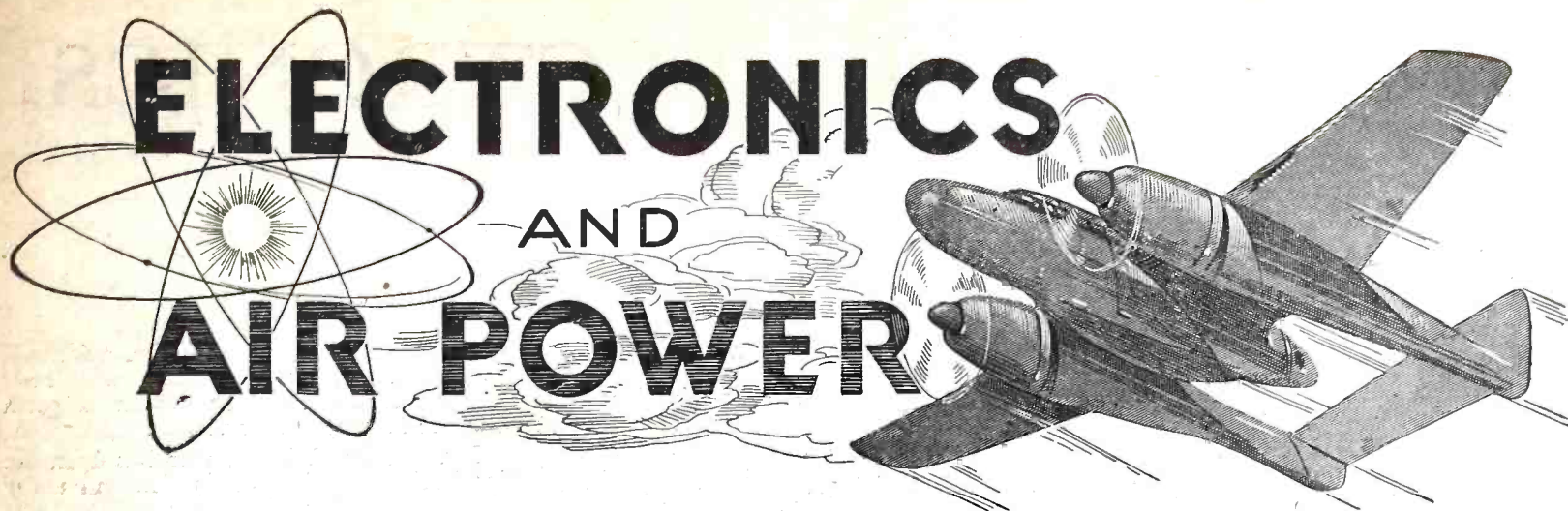

By TED POWELL  
PART II

THE incredibly destructive havoc modern naval rifles can wreak simply cannot be put into words—it is something that must be seen and experienced to be in any way comprehended. A modern warship can empty its magazines of thousands of shells in from a quarter of an hour to one hour. A naval fleet can pour such terrific fire-power upon a concentrated area as to wreak destruction unequalled by anything else known to man. The pictures of Kwajalein reveal scenes of bleak and utter desolation seldom seen in any war. No aerial bombardment has even begun to approach such destructive power in such a limited space of time as was unleashed upon that little island in the South Pacific.

While some of the Pacific actions were wholly aerial, most of the campaigns were amphibious in their nature. Earlier in the war, a laconic Navy communique bluntly stated that when airpower was solely relied upon, the island-hopping Jap could not be halted in his advance and that a 50-50 air-and-sea combination was required for most successful actions.

It was here in the South Pacific that the value of American gun-control equipment was first demonstrated in the naval arm's successful fight against the enemy air arm.

No longer did the airman have a field day pouncing upon warships designed and built when airpower was only a dawning prophecy. They had no flexible communications or gunnery control systems, no superstructure designed to meet aerial attack and had no topside armor. They had only a few short-range 50-caliber machine-guns and 3" or 5" A.A. guns with obsolete controls designed to track antiquated planes which could move at only 200 to 250 miles per hour.

To attempt to knock down a squadron of modern 400-mile per hour planes with such outmoded equipment was much like trying to mow down a group of scampering jack-rabbits with an old 55-caliber horse-pistol.

Gradually, Axiom 2 and Axiom 3 began to operate and warship structure and A.A. battery design and defense tactics have been radically modified to meet the new offense.

To the Nazi boast that "the Luftwaffe will wipe the British Navy off the face of the seas" and that "seapower must go the way of the horse-car" we have the USS South Dakota's answer—32 Jap planes blasted into the sea in the space of 28 minutes. A whole squadron of enemy planes massacred by a single battle-wagon at the rate of over a plane a minute in perhaps the most brilliant example of high-speed precision A.A. gunnery seen in the war to date.

Her A.A. batteries have since been considerably expanded and improved—just how

cannot be divulged now. We can only surmise what the new 45,000 tonners have at their command in the way of A.A. defenses.

To illustrate how things have changed since the early days of the war—an American destroyer operating off the Sicilian coast was spotted by the pilot of a twin-engine bomber. He banked over and raced in, throttle wide open, to close in for a killing. He relied upon the old tactic of diving close to the water to confuse the director crew's judgment and hurtling directly forward at great speed to outwit the gun computers and to thin out the effective fire-power of the ship's A.A. guns. He evidently must have been familiar with the older early war Allied men-o-war and probably did not figure on new equipment.

A keen-eyed youngster manning a 40 MM director swung his sight on to the small target and the gun followed after the sight smoothly and obediently.

When the plane filled the sight, the operator's trigger hand moved almost imperceptibly and eight spaced roaring barks split the afternoon air like the slamming of eight giant doors. What was a magnificent aerial fighting machine splintered and disintegrated into a burst of rubbish and sprinkled the sea.

A new flexible maneuverable high-speed attack weapon was countered with a new flexible maneuverable defense weapon, and was blasted out of existence in the fraction of the few seconds that separated it from its intended prey.

Once again, Axiom 2 was dramatically demonstrated.

Initial Axis air successes against Allied naval units were due not to any intrinsic superiority of aerial weapons over sea units but to these three simple facts:

(1) Allied naval design men were caught flat-footed by the whirlwind development of the airplane.

(2) Allied naval officers and ordnance men were caught off-guard by a new offensive weapon and new aerial offense tactics.

(3) A relatively cheap unit like a warplane could be swiftly improved or discarded as the occasion demanded while a massive and costly warship could not.

Thus ship top-side armor plating and superstructure had to be drastically redesigned, new A.A. weapons and defenses developed and expanded, new A.A. gunnery techniques evolved, new battle-phone and gunnery fire-control systems modified and expanded in order to achieve flexible control, new communication devices had to be perfected and officer and crew battle organization and training had to be revised. All this could not be accomplished overnight—it took time. Thus the apparently overwhelming superiority of the air arm over the naval unit.

The great speed and striking power of the plane formerly gave it a considerable time and surprise advantage over the warship. A plane could approach a war vessel undetected high over cloud banks, dip in flat "V's" through the cloud layers, blast its target and slip back into the

(Continued on page 34)

The electronic gun director brought out this year by Bell Laboratories. Seated at the tracking telescopes are Major General Levin H. Campbell, Jr., the Army's Chief of Ordnance, and Dr. Oliver E. Buckley, President of the Bell Telephone Laboratories.

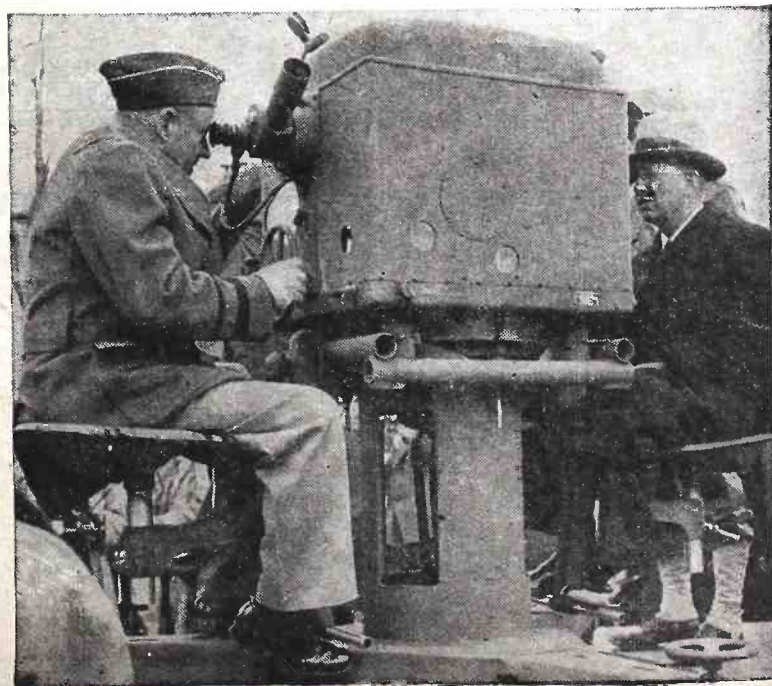

# INDUSTRIAL ELECTRONICS

## PART VIII—GEOPHYSICS AND GEOLOGY

**A** FEW YEARS AGO no one would have dared dream that geology, geophysics, and the mining and petroleum industries would be affected even in a small measure by the same little vacuum tubes that were bringing Kate Smith and Amos and Andy. Yet this has come to pass and today the earth is being probed as never before for its treasure. Electronic instruments of many kinds are being used by geologists and experimenters in this and related fields.

Some time ago, the hydraulic laboratory of the Massachusetts Institute of Technology was called upon to investigate tidal conditions in the Cape Cod Canal. Due to a rising tide at one end and a lower one

By **RAYMOND F. YATES**

at the opposite end, extremely dangerous currents were usually present and great property damage often resulted.

The M.I.T. Hydraulic Laboratory built a relatively large-scale model of the Canal and installed electronic depth meters connected to central recording instruments. Thus the engineers studying the problem could quickly observe the precise tidal conditions prevailing at any moment.

This same institution also has been experimenting with earthquakes, indeed actually reproducing earthquakes in miniature by the aid of certain electronic equipment involving the photo-electric cell. The

object of such research is to find a formula for building construction that will, in a larger measure, resist the action of earth tremors no matter how violent.

Mr. Arthur C. Ruge, who has been the inspiration of this investigation and under whose auspices it has been guided, first takes an actual seismographic record of an earthquake and then projects it on a screen to obtain a suitable and accurate enlargement. A permanent photographic record is transferred to paper mounted on a large revolving wheel. Thus a shadowgraph, as seen in Fig. 1, is produced. By means of a light beam and a phototube it is possible to translate this purely mechanical record of a quake into electrical terms.

A powerful amplifier is connected to the phototube which controls the very heavy current passing through the electromagnetic control valve on the large hydraulic cylinder holding oil under pressure. Thus the pressure in the oil cylinder is directly controlled by the shadowgraph revolving before the phototube.

The earth tremors in miniature are recreated by connecting the piston of the hydraulic cylinder directly to a shaking table where the miniature and experimental buildings are placed.

Mining engineers and exploratory geologists have long since sought a method or device whereby a large part, if not all, of the speculation in sinking mines and wells could be eliminated. While many methods have been proposed in past years, it remained for electronic equipment to solve this vexing and important problem. The present system not only solves the problem for the oil geophysicist but it also promises to become an important tool in the science of geology at large. Today electronic equipment is not only employed in the seismic method but in the thermal, magnetic, electric and gravitational methods as well.

The electronic amplifier is now being successfully employed in connection with gravity meters which are able to measure the gravitational field of the earth to within one part in 10,000,000. Thus electronics is of great value in temperature control apparatus and the gravity indicating elements.

Most readers have already heard of electrical "treasure finders" or "metal locators" that take advantage of the variable electrical properties of the upper strata of the earth. Before the advent of electronic amplifiers, these devices, no matter how cleverly made, were not successful. For one thing, they lacked sensitivity; they could not properly distinguish between small effects. Yet it was necessary that such distinctions be made accurately if the device was to function with any reasonable percentage of certainty. Electronic advancements of recent years are responsible for the instruments now regularly employed in measuring the potential of the earth, polarization effects, radio field strength, etc. Both alternating, direct and transient currents are utilized in the investigations now being conducted with such equipment. High-gain amplifiers are also commonly used in these devices.

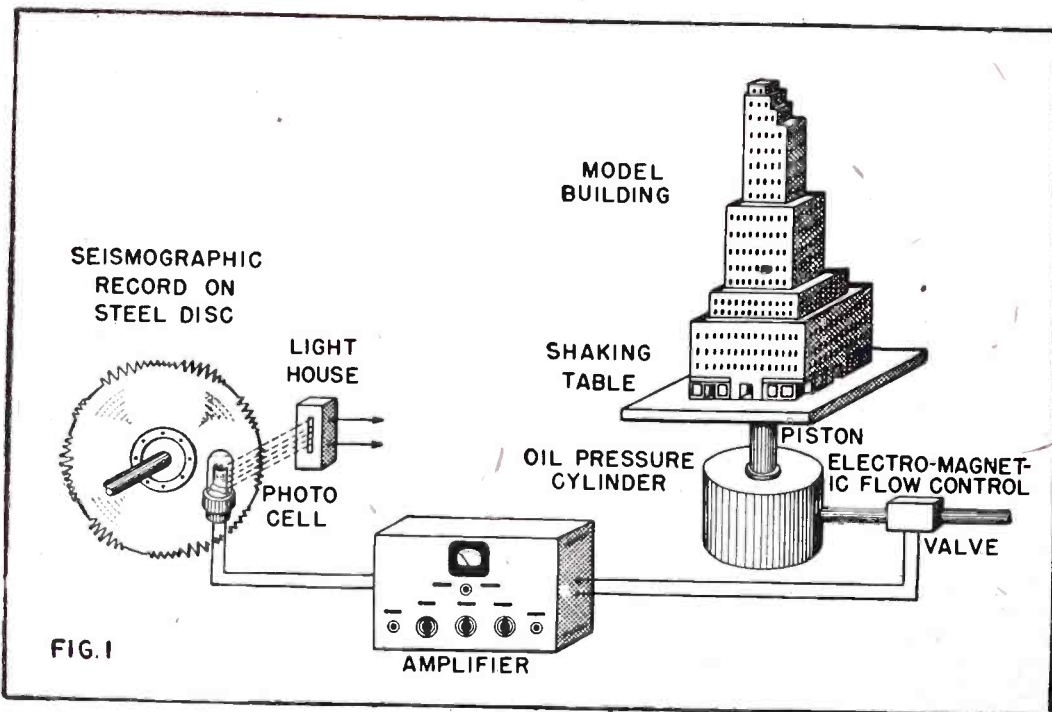

An electronic shaking table used in studying the effects of earthquake shocks on buildings.

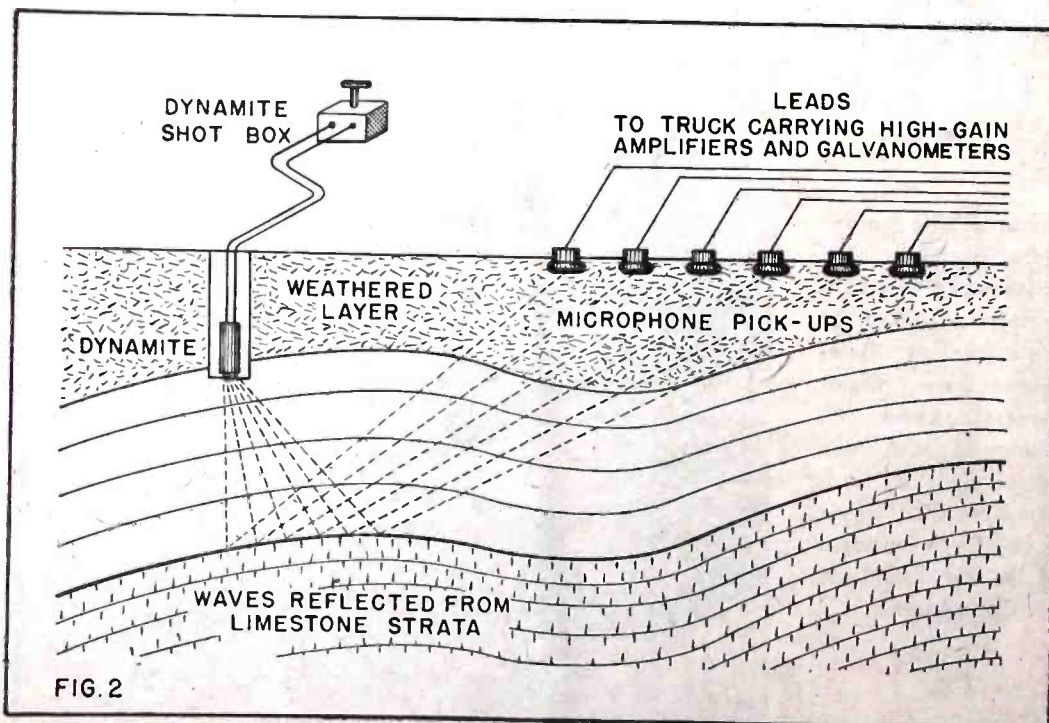

Reflected sound used to map subterranean rock strata is an important aid to prospecting.

(Continued on page 50)

# PRACTICAL ELECTRONICS

## PART VII—GRID-CONTROL METHODS

By FRED SHUNAMAN

**T**O control the output of rectifiers like thyratrons and ignitrons, a means of firing them at the correct instant in the cycle is necessary. Such means may be direct-voltage supplies; combinations of resistance, inductance and capacity; or special types of three-phase transformers.

The simplest of all control devices is a direct bias voltage on the thyatron grid, which does not permit the tube to fire till the anode voltage has reached a certain predetermined value. Such a device is simple, but its control is limited. It permits firing at any selected instant from the time the anode becomes positive till it reaches peak voltage. If the tube does not fire by the time anode peak voltage is reached, it cannot fire at any time in the cycle. (See Fig. 3, Lesson VI, in last month's *Radio-Craft*.)

The direct-bias method permits control from 50% to maximum output. This is sufficient for a number of applications. For others, it is desirable that the output be controlled from zero to maximum. In such cases, the alternating voltage supplied to the anode can be tapped for firing voltage, and by simple combinations of resistance, capacity and inductance can be made to fire the tube at any instant in the cycle.

### RESISTANCE AND REACTANCE

A capacity placed in a circuit causes the voltage to lag behind the current. This means simply that when a condenser is

connected to a source of electricity current will flow into it till it is full, and only then will the voltage across the condenser equal the full line voltage. When current starts to flow into the condenser the two terminals may be at about the same voltage, and it is only as more electrons crowd onto one set of plates and equal numbers are forced off the other that the voltage between them becomes greater. When the condenser is fully charged, no more current flows into it and its voltage is the same as that across the line. This effect can be used to make the voltage on the grid of a thyatron reach the firing point later in the cycle than the instant the plate becomes positive.

An inductance causes current to lag behind the voltage, or creates *voltage lead*. Every serviceman knows that when an ohmmeter is placed across a very large inductance, the meter swings up in a dignified way to indicate the resistance, instead of jumping over to the indicated value as it does when measuring a resistor. As soon as the ohmmeter voltage is placed across the inductor, a current starts to flow, which sets up a magnetic field in the many turns of the coil. This magnetic field attempts to force a current through the inductor in a direction opposite to that from the ohmmeter battery. It is this "bucking current" which slows down the rise of battery current. If the inductance is very large, it may be a second or more before the pointer reaches its maximum and stops.

Here are two devices which can slow down or speed up the

electric voltage. By inserting a transformer in the circuit and using one or the other of them, we can devise a grid circuit in which the grid voltage rises above zero (which we can consider as the firing point) sooner or later than the anode voltage. By the use of a

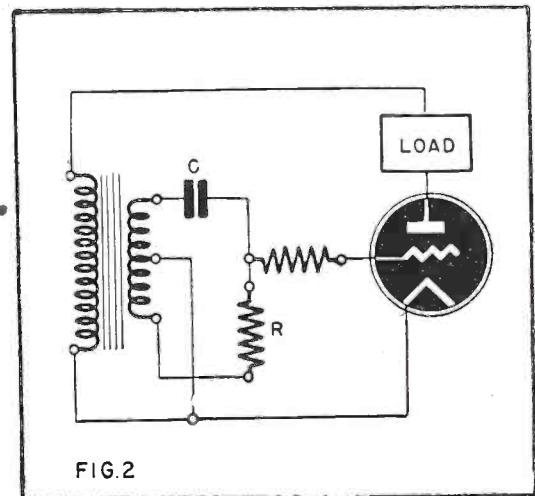

FIG. 2

Fig. 2—By correctly proportioning C and R the desired shift of phase may be obtained.

resistor and either a capacitor or inductor we can control the exact instant of firing.

If the circuit contains inductance alone the voltage is a quarter-cycle ahead of the current; if capacitance alone, the voltage lags a quarter-cycle behind. If resistance is combined with either of the other two, the effect will be a compromise, or intermediate shift of phase, depending on the respective quantities of each element.

(Continued on page 52)

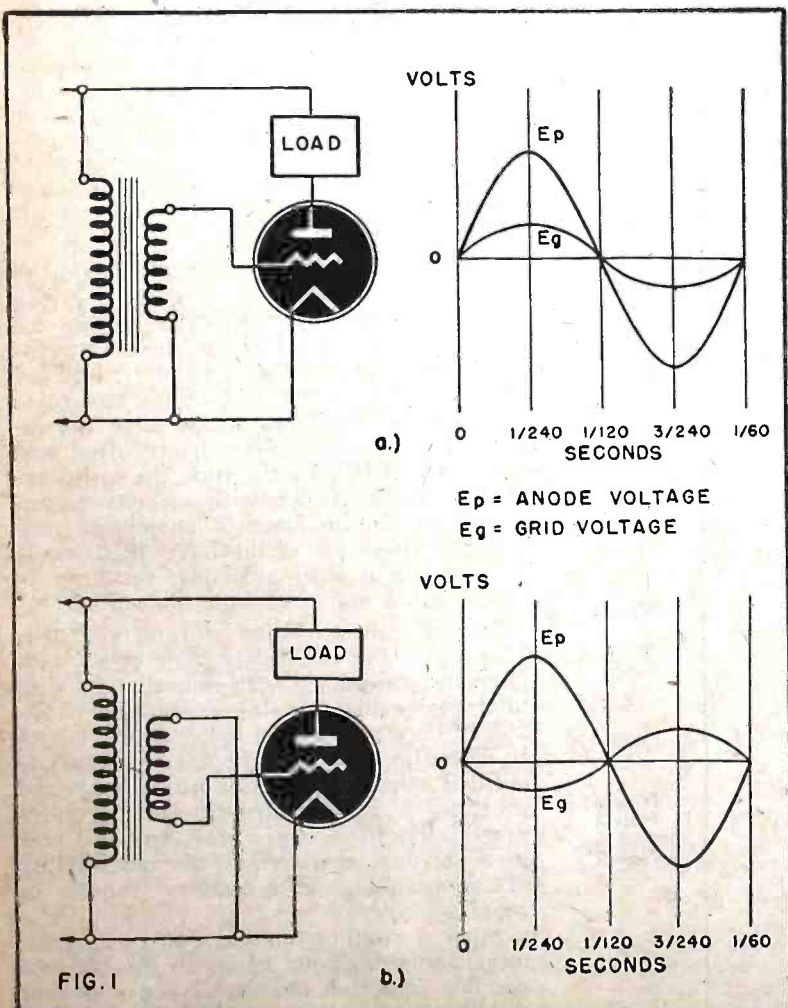

Fig. 1, left—How phase of grid and plate voltages can be shifted through 180 degrees.

Fig. 3, below—No matter what the angle, the voltage remains constant and equal to half that of the secondary.

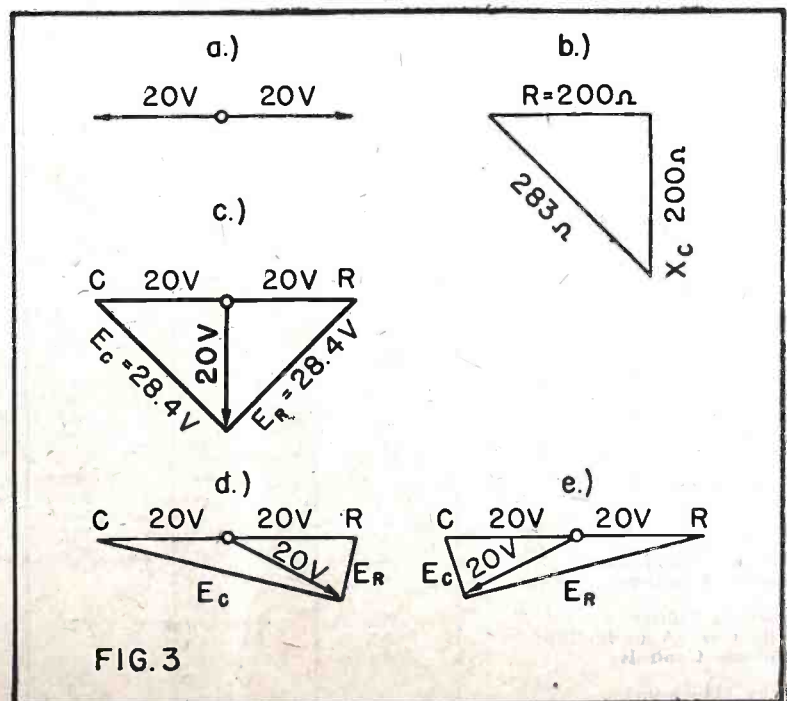

FIG. 3

# PRIORITY PROBLEMS

By EUGENE CARRINGTON\*

**W**HAT can I buy without priority? Where is priority assistance required, which of the regulations pertaining to me do I use, and how do I go about it? These are important questions facing the serviceman and dealer today.

\* Priorities Division, Allied Radio Corporation, Chicago.

In presenting basic answers to these broad questions, two important factors must be taken into consideration, (1) Problems of supply and demand are constantly undergoing rapid change and (2) Priority regulations are necessarily amended to keep step with the changes. This means that whereas regulations and routines described here are in effect at the time of going to

press, changes may have been made between now and the time your purchase is placed. Do not be surprised, therefore, if your distributor asks you for other or additional priority assistance or tells you that he is unable to fill your order because of recent limiting restrictions.

## HOW TO USE THIS GUIDE

First select the items you wish to purchase as listed in the left-hand column in the chart. The asterisks (\*) in the columns immediately to the right will indicate the procedure under which each item falls. A basic explanation of each method of application is given in the paragraphs following the chart. Since it is impossible, however, in the space of a single article to cover the full text of all orders and regulations discussed, it is suggested that you secure a copy of each from your WPB Field Office and read them over carefully in order to fully familiarize yourself with all do's, don'ts, and limitations involved.

## YOUR WPB FIELD OFFICE

Your nearest War Production Board Field Office will gladly mail you without cost complete copies of regulations and such priority forms as you may request. Instructions for filing the latter with your supplier or the War Production Board, as required, are also available. The personnel of each field office is equipped and ready to help you to the fullest extent. That is why these offices are maintained. Feel free to consult them whenever any problem arises which you do not fully understand.

Do not write to WPB in Washington except where specifically advised to do so by your field office or where specific applications require this procedure. Your field office has all the information and forms you need and can give you faster and more personalized action than the overburdened Washington office possibly can. A complete list of field offices is given on the following page.

Many servicemen make the mistake of writing one or more distributors, giving each a list of requirements and asking for information as to which of these is available from stock. The frequent result of this procedure is the loss of his chance to obtain parts available at the time his inquiry is received, but which are often sold and out of stock by the time the order arrives. Had an order with priority extension been sent in place of an inquiry, immediate shipment could have been made on everything then available, resulting in considerable saving of time and effort.

If you want to "shop" for merchandise, your safest bet is to place your order with your preferred distributor immediately, with instructions that he ship everything available at once and let you know approximately when he expects to be able to ship any unfilled balance. With this information and probably a large share of your requirements already on their way, you are now in a position to determine the advisability of approaching a secondary source of supply.

Such a routine not only puts the most merchandise in your hands in the shortest possible time, but also saves you and your distributor the extra burden of needless

Product	L-265	CMP-5	CMP-9A	WPB-541	Special Notes
Auto Aerials	*				Note 1
Audio Transformers	*				Note 2
Ballasts	*				
Batteries					
Battery Packs					Note 3
Cabinets					
Wood	*				
Metal			*		
Chassis Bases		*	*		
Chokes					
Iron Core	*				
Air Core	*				
Condensers					
Electrolytic	*				Note 2
Mica Dielectric	*				Note 2
Paper Foil	*				Note 2
Variable	*				
Copper-Oxide Rectifiers			*		
Dial Belts	*				
Dial Plates	*				
Dry Rectifiers			*		
Fuses			*		
Grid Caps	*				
Hardware			*		
Insulators					
Intercom. Equipment				*	Note 1
Inverters				*	
Jacks	*				
Jack Plugs	*				
Jack Switches	*				
Knobs (Molded)	*				
Line Ballasts	*				
Line-Cord Resistors	*				
Meters (Single Range)		*		*	
Microphones		*		*	
Microphone Stands		*			
Mounting Strips	*				
Padding Condensers	*				
Phono Cartridges					Note 5
Phono Needles					Note 1
Phono Pickups					Note 1
Pilot Lamps	*				
Plugs (AC Line)	*				Note 1
Plugs (Jack Type)	*				
Potentiometers	*				Note 2
Power Transformers	*				Note 2
Public Address Equipment	*			*	Note 4
Recording Discs	*				Note 1
Recording Needles	*				Note 1
Relays	*				
Remote Control Parts	*		*		
Resistors (Carbon)	*				
Resistors (Wire Wound)	*				
Rheostats	*				Note 2
Sockets	*				
Solder					Note 1
Soldering Irons					
Spaghetti	*	*			
Speakers (Complete)	*	*			
Cone Assemblies	*				
Field Coils	*				
Suppressors	*				
Switches	*				
Test Equipment		*		*	
Tone Controls					Note 6
Tools	*	*			Note 2
Transformers	*	*			
Trimmer Condensers	*				Note 2
Tuning Condensers	*				
Vacuum Tubes	*				
Vibrators (Auto Radio)	*				
Volume Controls	*				
Wire (Hook-up)			*		



added correspondence which is an important factor in itself.

### YOUR ORDER OF PREFERENCE

The certification or preference rating which you extend with your order does one or more things: (1) It certifies your right to make the purchase, (2) it establishes your order of preference for delivery, and (3) it permits your distributor to order the same merchandise from his supplier to replace in his stock the items shipped to you or to secure these things for you in the event they are not in stock.

If the items you want are in stock and you have extended the required certification or preference rating with your order, immediate shipment will be made. Where stock is not on hand, however, your chances of delivery are dependent upon how quickly the manufacturer can fill the order placed upon him by your distributor. How soon this will be depends upon (1) the date on which the next production run is scheduled and (2) how many higher rated purchases are ahead of yours. In other words, until the "cup" of the Armed Forces is filled to overflowing, the rest of us must "stand by."

There are exceptions to this general rule where the War Production Board has directed that a percentage of production be diverted each month for civilian requirements. Tubes and batteries, for instance, have both been allocated in this manner. The quantities thus made available are necessarily small and are, therefore, distributed on a pro-rata basis. Every serviceman is entitled to his share, but it will not be a full share as long as military needs exceed the supply.

Shortages and delays must under these circumstances continue to exist. The excellent cooperation on the part of all concerned, however—the Consumer, the Serviceman, the Distributor, the Manufacturer, and the War Production Board—has resulted in an equitable distribution to all groups of the available equipment in the Electronics field.

### SPECIAL NOTES

1. No priority or certification required where item is available from distributor's stock. Some of these items have been discontinued from production. Others are still being produced, but are available in limited quantities on a pro-rata allocation basis.
2. Covers Victory Line (...V) types only, manufactured in conformance with standards developed by the ASA War Standards Committee on Replacement Parts for Civilian Radio, at the request of the Office of Price Administration after consultation with the Radio and Radar Division of the War Production Board. In each case a minimum number of types have been chosen as adequate for servicing the majority of home radio receivers. Minimum performance requirements are designed to furnish parts, using a minimum of strategic materials so as not to severely restrict production and yet produce units which are satisfactory from an electrical and service-life standpoint.
3. Made available in limited quantities on a pro-rata allocation basis. No priority or certification necessary.
4. Public Address and Intercom systems used for paging, transmitting information, emergency warnings, and for music during working hours, should be applied for on form WPB-617 in such cases where construction is required or on form WPB-541 where no construction is needed. These forms should be filed by the purchaser or ultimate user through his purchasing department. The serviceman is then permitted to extend any priority granted for this purpose. Consult your WPB Field Office for detailed instructions.
5. New units not available. Old unit must be returned for repair or exchange. No priority or certification required.
6. Test instruments and multi-range meters are covered by WPB Scheduling Order M-293 and require specific application on form WPB-3243 except for those instruments which from time

### DIRECTORY OF FIELD OFFICES, WAR PRODUCTION BOARD

State	City	Region	Number and Street
Alabama	Birmingham 1	4	1706 Second Avenue, North
Arizona	Phoenix	10	234 North Central Avenue
	Tucson	10	68 East Congress Street
Arkansas	Little Rock	7	221 West 2nd Street
California	Los Angeles 15	10	1031 South Broadway
	San Diego 1	10	530 Broadway
	San Francisco 3	10	1355 Market Street
Colorado	Denver 2	9	1755 Glenarm Street
	Pueblo	9	Fifth and Main Streets
Connecticut	Bridgeport 3	1	144 Golden Hill Street
	Hartford 4	1	119 Ann Street
	New Haven 10	1	152 Temple Street
Delaware	Wilmington 50	3	French and Water Streets
District of Columbia	Washington 25	3	
Florida	Jacksonville 1	4	314 West Monroe Street
	Tampa 2	4	608 Tampa Street
	Atlanta 1	4	127 Peachtree Street, N. E.
Georgia	Honolulu 2	10	
Hawaii	Boise	10	805 Idaho Street
Idaho	Chicago 6	6	226 West Jackson Boulevard
Illinois	Decatur 80	6	108 South Water Street
	Peoria 2	6	410 Main Street
	Rockford	6	303 North Main Street
Indiana	Evansville 8	6	112 Northwest 4th Street
	Fort Wayne 2	6	114 East Wayne Street
	Indianapolis 4	6	5 East Market Street
	South Bend 9	6	Michigan and Jefferson
Iowa	Davenport	6	326 West 3rd Street
	Des Moines 9	6	418 6th Avenue
Kansas	Wichita 2	7	106 South Broadway
Kentucky	Louisville 2	5	139 South Fourth Avenue
Louisiana	New Orleans 12	8	200 Barrone Street
Maine	Portland 3	1	142 High Street
Maryland	Baltimore 2	3	10 Light Street
Massachusetts	Boston 8	1	17 Court Street
	Springfield 3	1	1200 Main Street
	Worcester 8	1	340 Main Street
Michigan	Detroit 2	11	7310 Woodward Avenue
	Grand Rapids 2	11	60 Division Avenue, North
	Saginaw	11	124 South Jefferson Avenue
Minnesota	Duluth 2	12	120 North Fourth Avenue, West
	Minneapolis 1	12	407 2nd Avenue, South
Mississippi	Jackson 1	4	127 South Roach Street
Missouri	Kansas City 6	7	405 East 13th Street
	St. Louis 1	7	818 Olive Street
Montana	Helena	12	7 West Sixth Avenue
Nebraska	Omaha 2	7	405 South 16th Street
Nevada	Reno	10	106 E. Second Street
New Hampshire	Manchester	1	396 Canal Street
New Jersey	Newark 2	2	20 Washington Place
	Trenton	3	143 East State Street
New Mexico	Albuquerque	9	103 1/2 West Central Avenue
New York	Albany 7	2	112 State Street
	Brooklyn 2	2	16 Court Street
	Buffalo 3	2	14 Lafayette Square
	New York 1	2	350 Fifth Avenue
	Rochester 4	2	119 Main Street, East
	Syracuse 2	2	224 Harrison Street
	Utica 2	2	185 Genesee Street
North Carolina	Charlotte 2	4	730 East Trade Street
	Raleigh	4	16 West Martin Street
North Dakota	Bismarck	12	202 1/2 Third Street
	Fargo	12	322 Fifth Street, North
Ohio	Akron 8	5	106 South Main Street
	Canton 2	5	120 Tuscarawas Street, West
	Cincinnati 2	5	34 East 4th Street
	Cleveland 1	5	925 Euclid Avenue
	Columbus 15	5	145 North High Street
	Dayton 2	5	129 South Ludlow Street
	Lima	5	212 North Elizabeth Street
	Toledo 4	11	245 Huron Street
	Youngstown 3	5	16 Central Square
Oklahoma	Oklahoma City 2	8	407 North Harvey Avenue
	Tulsa 3	8	420 South Boulder Street
Oregon	Portland 4	13	520 Southwest 6th Avenue
Pennsylvania	Allentown	3	506 Hamilton Street
	Erie	5	16 E. 12th Street
	Harrisburg	3	112 Market Street
	Johnstown	5	216 Franklin Street
	Philadelphia 3	3	1617 Pennsylvania Boulevard
	Pittsburgh 22	5	511 Wood Street
	Scranton 3	3	207 Wyoming Avenue
Puerto Rico	San Juan		San Juan 46
Rhode Island	Providence 3	1	111 Westminster Street
South Carolina	Columbia 56	4	1306 Senate Street
South Dakota	Sioux Falls	12	133 North Main Avenue
Tennessee	Knoxville 010	4	521 Market Street
	Memphis 1	4	8 North Third Street
	Nashville 3	4	234 Third Avenue, North
Texas	Dallas 2	8	106 South Ervay Street
	El Paso	8	306 East San Antonio Street
	Houston 2	8	1016 Walker Avenue
	San Antonio 6	8	310 South St. Mary's Street
Utah	Salt Lake City 1	9	36 1/2 West 2nd Street, South
Vermont	Montpelier	1	84 State Street
Virginia	Norfolk 10	3	236 Granby Street
	Richmond 13	3	703 East Franklin Street
Washington	Seattle 1	13	1318 Fourth Avenue
	Spokane 8	13	1023 West Riverside Avenue
West Virginia	Charleston 30	5	1031 Quarrier Street
Wisconsin	Eau Claire	6	128 1/2 Graham Avenue
	Green Bay	6	206 Main Street
	Madison 3	6	119 East Washington Avenue
	Milwaukee 1	6	161 West Wisconsin Avenue
Wyoming	Casper	9	202 E. 2nd Street

to time are released as available under priority application only, in which case order should be placed under CMP-5 regulations or, in case of emergency and where higher priority is required, application should be made on form

WPB-541. Ask your WPB Field Office for copy of M-293 Scheduling Order and Table 9 as amended April 15, 1944, also copy of form WPB-3243 which contains complete instructions (Continued on page 64)

# World-Wide Station List

Edited by ELMER R. FULLER

**N**EW station WNRA in New York City is using two frequencies, 6.100 mcs. from 11:45 pm to 2 am and 18.160 mcs. from 10 am to 5:15 pm. Both transmissions are beamed toward Europe.

Another newcomer to the short-wave bands is DHE4B heard on 11.760 mcs. and 11.840 mcs. It is located in Podiebrad, Bohemia and is believed to be German-operated. They sign on at 6 pm on both frequencies.

More reports each month would do a lot to help make this list better and more accurate. Why not let us and our readers share in your listening results? You will be helping yourself as well as others. All schedules below are Eastern War Time.

Mc.	Call	Location and Schedule	Mc.	Call	Location and Schedule	Mc.	Call	Location and Schedule
3.500	COCX	HAVANA, CUBA; heard evenings.	9.525	—	LONDON, ENGLAND; European service.	9.58	VLG	MELBOURNE, AUSTRALIA; 11 to 11:45 am.
4.99	YV3RN	BARQUISIMETO, VENEZUELA; heard evenings.	9.530	WGEO	SCHENECTADY, NEW YORK; East South America beam, 5:30 pm to midnight.	9.590	WCRC	NEW YORK CITY; European beam, 4 to 6:45 am.
6.100	WNRA	NEW YORK CITY; European beam, 11:45 pm to 2 am.	9.530	WGEA	SCHENECTADY, NEW YORK; European beam, 3:15 to 8 am.	9.59	WLWO	CINCINNATI, OHIO; West South America beam, 7 pm to midnight.
8.985	COKW	HAVANA, CUBA; evenings.	9.530	KGEX	SAN FRANCISCO, CALIF.; Oriental beam, 5 to 10:45 am.	9.59	—	TOKYO, JAPAN; heard 9:20 to 9:30 am.
9.03	COBZ	HAVANA, CUBA.	9.535	JZI	TOKYO, JAPAN; noon to 1:45 am.	9.595	—	ATHLONE, IRELAND.
9.100	ICA	NAPLES, ITALY; heard evenings calling CBS.	9.535	—	UNITED NATIONS RADIO—ALGIERS.	9.600	—	ROME, ITALY; heard late afternoons.
9.125	HAT4	BUDAPEST, HUNGARY.	9.535	SBU	MOTALA, SWEDEN.	9.600	GRY	LONDON, ENGLAND.
9.130	HI2G	CIUDAD TRUJILLO, DOMINICAN REPUBLIC.	9.539	—	BERN, SWITZERLAND; heard evenings.	9.600	CE960	SANTIAGO, CHILE.
9.185	—	BERN, SWITZERLAND; off at 11 pm; to South America at 7:30 to 9 pm.	9.540	VE9AI	EDMONTON, CANADA; no sked yet.	9.607	HP5J	PANAMA CITY, PANAMA; evenings.
9.185	COCQ	HAVANA, CUBA.	9.540	VLG2	MELBOURNE AUSTRALIA; 8 to 8:45 am.	9.608	ZRL	CAPE TOWN, SOUTH AFRICA.
9.250	COBQ	HAVANA, CUBA.	9.540	—	BERLIN, GERMANY; evenings till after 11 pm.	9.610	DXB	BERLIN, GERMANY; evenings.
9.255	—	BUCHAREST, ROUMANIA; 4 to 5 pm.	9.540	—	HSINGKING, MANCHUKUO.	9.610	ZYC8	RIO DE JANEIRO, BRAZIL.
9.26	GSU	LONDON, ENGLAND.	9.54	MTXY	VERA CRUZ, MEXICO; 11 am to 2 am.	9.615	XERQ	MEXICO CITY, MEXICO.
9.290	HI2G	DOMINICAN REPUBLIC.	9.543	XEFT	SCHENECTADY, NEW YORK; European beam, 5 to 9 pm.	9.615	VLC	MELBOURNE, AUSTRALIA; 11 to 11:40 am.
9.295	COCX	HAVANA, CUBA.	9.550	—	"RADIO SHONAN," SINGAPORE; heard at 7:25 to 7:30 am.	9.615	TIPG	SAN JOSE, COSTA RICA.
9.35	COBC	HAVANA, CUBA.	9.550	GWB	LONDON, ENGLAND.	9.620	—	ADDIS ABABA, ETHIOPIA.
9.437	COCH	HAVANA, CUBA.	9.555	XETT	MEXICO CITY, MEXICO.	9.62	—	VICHY, FRANCE.
9.455	GRU	LONDON, ENGLAND.	9.560	—	BERLIN, GERMANY; evenings till after 11 pm.	9.630	CBFX	MONTREAL, CANADA.
9.465	TAP	ANKARA, TURKEY.	9.562	OAX4T	LIMA, PERU.	9.630	2RO3	ROME, ITALY.
9.470	CR6RA	LOUANDA, ANGOLA.	9.565	JRAK	MOSCOW, USSR.	9.64	LRI	BUENOS AIRES, ARGENTINA.
9.480	CP38	LA PAZ, BOLIVIA.	9.565	—	PARAO, PALAU GROUP.	9.64	KZRH	MANILA, PHILIPPINES; 6 to 7 am.
9.490	WCBX	NEW YORK CITY; Brazilian beam, 5 to 11:30 pm.	9.57	KWIX	SAN FRANCISCO, CALIF.; Oriental beam, 6:45 to 10:45 am.	9.640	CXAB	MONTEVIDEO, URUGUAY.
9.490	KRCA	SAN FRANCISCO, CALIF.; Oriental beam, 2 am to 12:30 pm.	9.570	KWID	SAN FRANCISCO, CALIF.; South America beam, 8 pm to 12:45 am.	9.64	CMZ	HAVANA, CUBA.
9.490	WCBN	NEW YORK CITY; European beam, 2:15 to 3:30 am.	9.580	GSG	LONDON, ENGLAND; North America beam, 5:15 pm to 12:45 am.	9.645	JLT2	TOKYO, JAPAN.
9.495	OIX2	HELSINKI, FINLAND.				9.646	XGOY	CHUNGKING, CHINA; East Asia and South Seas beam, 7:35 to 9:40 am; North American beam, 9:45 to 11:40 am; European beam, 11:45 am to 12:30 pm; East Asia and South Seas beam, 12:30 pm to 1:45 pm.
9.500	XEW7	MEXICO CITY, MEXICO; 9 am to 3 am.				9.650	DJW	BERLIN, GERMANY.
9.505	JLG2	TOKYO, JAPAN; North American beam, 11:20 pm to 1:15 am.				9.650	WOOC	NEW YORK CITY; European beam, 5:15 to 6:45 pm; 7 to 9:15 pm.
9.510	HS8PJ	SALADENG, THAILAND.				9.655	VLW4	PERTH AUSTRALIA.
9.510	GSB	LONDON, ENGLAND; 2 to 3 pm.				9.660	VUD6	DELHI, INDIA.
9.520	—	COPENHAGEN, DENMARK; heard 8 to 11 pm.				9.660	VLQ3	BRISBANE, AUSTRALIA.
9.52	DXL13	PARIS, FRANCE.				9.660	LRX	BUENOS AIRES, ARGENTINA.
						9.660	HVJ	VATICAN CITY.
						9.665	XGO1	SHANGHAI CHINA.
						9.665	VLW4	PERTH, AUSTRALIA.
						9.670	WNBI	NEW YORK CITY; European beam, 4 to 7:30 am; 3:45 to 5:15 pm.
						9.670	WRCA	NEW YORK CITY; Brazilian beam, 8 to 11:30 pm.
						9.675	DJX	BERLIN, GERMANY.
						9.675	JVW2	TOKYO, JAPAN; 5 to 8 am; 10 am to 12:15 pm.
						9.680	XEQQ	MEXICO CITY, MEXICO.
						9.68	VLW6	PERTH, AUSTRALIA; 9:40 to 10:40 am.
						9.685	TGWA	GUATEMALA CITY, GUATEMALA.
						9.690	GRX	LONDON, ENGLAND; North America beam, 5:15 to 10:15 pm.
						9.69	LRA1	BUENOS AIRES, ARGENTINA.
						9.693	JIE2	TAIHOKU, FORMOSA.
						9.700	WRUW	BOSTON, MASS.; European beam, 2:15 to 4 am.
						9.700	WRUS	BOSTON, MASS.; Central America beam, 7:30 pm to 2 am; North African beam, 6 to 7:30 am; 6:15 to 7:15 pm.
						9.700	WRUA	BOSTON, MASS.; North African beam, 4:45 to 6 pm.
						9.700	FIQA	TANANARIVE, MADAGASCAR.
						9.705	—	FORT DE FRANCE, MARTINIQUE.
						9.715	OAX4K	LIMA, PERU.
						9.720	XGOA	CHUNGKING CHINA.
						9.720	PRL7	RIO DE JANEIRO, BRAZIL; 4:10 to 9:50 pm.
						9.724	CSW	LISBON, PORTUGAL.
						9.730	XGOA	CHUNGKING, CHINA; 1:30 to 2:40 am; 6:30 to 10 am.
						9.730	CE970	VALPARAISO, CHILE.
						9.735	CXA15	MONTEVIDEO, URUGUAY.
						9.740	CSW7	LISBON, PORTUGAL.



Suggested by Arthur T. Stanton, Washington, D. C.  
"Isn't television wonderful!" "You mean Smellivision, don't you?"

(Continued on page 55)



## Research gives TELEVISION new horizons

● TELEVISION RAYS—like human sight—do not “bend” far beyond the curvature of the earth. They travel in a straight line to the horizon—and from the horizon off into space. In preparing television as a service to the public, research has sought ways to extend television’s program service by radio relaying from city to city.

A solution to this problem has been perfected by RCA engineers: the radio relay station—capable of picking up and automatically “bouncing” tele-

vision images from station to station. With such relays supplementing a coaxial cable, entertainment, sports and news events could be witnessed simultaneously by Americans from coast to coast.

Today, RCA’s research facilities are devoted to providing the Allied fighting forces with the most efficient radio and electronic equipment available. Tomorrow, these same skills and energies will continue to serve America in developing and creating new and finer peacetime products.



**RADIO CORPORATION OF AMERICA**

RCA LABORATORIES · PRINCETON · NEW JERSEY

**RCA**  
leads the way in  
radio—television—  
phonographs—records  
—tubes—electronics



Listen to RCA's "The Music America Loves Best"—Sunday, 4:30 P.M., E.W.T., over the NBC Network ★ BUY WAR BONDS EVERY PAY DAY ★

**9 out of 10**  
**BUSY RADIO**  
**TECHNICIANS SAID**

**"HERE'S THE WAY  
 TO LEARN  
 RADIO RIGHT!"**

**GHIRARDI**  
**TEACHES IT TO YOU**  
**EASIER • BETTER • FASTER**

**724 OUT OF 817!** When you want the facts about something—go to the men who know! When you want to find out what is the best Radio-Electronic Training for YOU—ask Radio-Electronic men! That was exactly our idea when we went to a mixed group of 817 radio-electronic men—a group made up of instructors, students, repair men, radio-electronic experts in the armed forces and in big manufacturing plants. We asked them to tell us exactly what they think of various books and courses now being offered for the study of Radio-Electronic fundamentals. NINE OUT OF TEN of these men wrote back that Alfred A. Ghirardi's RADIO PHYSICS COURSE book is their choice as the best buy on the market—far better than any other book or course they have ever seen. And, as they explained—

**HERE ARE THEIR REASONS WHY:**

- 1 **"Its simple, clear way of thoroughly explaining every detail makes it the most easily understood of all Radio-Electronic books and courses.**
- 2 **"It teaches Radio-Electronic fundamentals more quickly and more interestingly than any other.**
- 3 **"It gives the most complete coverage of Radio and Electronic subjects—all in one handy volume.**
- 4 **"It is the most inexpensive, complete basic training available—easily worth from \$50 to \$100 if you bought it as a course."**

**FOR BEGINNERS . . .**  
**TRAIN AT HOME—In Spare Time**

Ghirardi's RADIO PHYSICS COURSE is tried and tested. It gives MAXIMUM training in MINIMUM time and at an absolute MINIMUM cost. You learn at home in spare time. You progress as fast as you want to. Actually Ghirardi's RADIO PHYSICS COURSE gives you the scope of 36 different courses in one—all packed into an easy-to-follow 972-page book with 508 clear illustrations, and 856 self-testing review questions. You can understand every word of it without previous training—and you'll be pleasantly surprised how easily you'll master the subjects that other books and courses make seem very complicated. Our 5-day Money Back Guarantee enables you to examine this great book for five full days—and get every cent of your money back if you're not more than satisfied.



Let A. A. Ghirardi—Radio's most widely-read technical author—help you start your training for a fascinating, profitable, wartime or peacetime job in the vast new Radio-Electronics field.

**MAIL THIS COUPON NOW!**

**RADIO & TECHNICAL DIVISION**  
**Murray Hill Books, Inc.**  
 Dept. RC-104, 232 Madison Ave., New York 16, N. Y.

Rush me a copy of your big, 972-page RADIO PHYSICS COURSE BOOK. I am enclosing \$5. (\$5.50 foreign.)

Send C.O.D. (In U.S.A. only) for \$5 plus postage.

In either case, I may return the book within 5 days for refund if I am not completely satisfied with it.

Name .....

Address .....

City (and Dist. No.) ..... State .....

**COMPLETE BASIC RADIO-ELECTRONIC TRAINING IN ONE BIG VOLUME**



**ONLY \$5**  
**Complete**  
 (Postpaid in the U.S.A.)

Easily worth \$50 if you bought it as a course

**NO OTHER COURSE LIKE IT**

There is no substitute for Ghirardi's RADIO PHYSICS COURSE—simply because there isn't any other book or course like it at any price. That's FACT—not fiction—and backed up by PROOF, not mere claims!

M. J. Turim of Brooklyn, N. Y., says: "I've read many Radio books but have failed to find a more detailed, thorough, and easy-to-understand book than Ghirardi's Radio Physics Course. It's the best course on the subject available today—ABSOLUTELY UNBEATABLE."

M. V. Suarez, Habana, Cuba, writes: "Having finished a \$121 Radio course from a technical school in the States, I don't find any difference in price or teaching between this and your Radio Physics Course at only \$5! Radio Physics Course is 'tops!'"

**ELECTRONICS, TOO!**

And don't forget, RADIO PHYSICS COURSE does not end at teaching you only Radio! The basic instruction you get from this big book is your introduction to the vast, rapidly growing field of Electronics, too. It is your "Open Sesame!" to more money and a better job in this amazing new industry you've been reading so much about.

Order your copy today. SEE it. EXAMINE it for yourself. Here is our GUARANTEE:

**YOUR MONEY BACK IN 5 DAYS**  
 If Ghirardi's Big 972-page RADIO PHYSICS COURSE doesn't teach you RADIO-ELECTRONIC fundamentals EASIER, FASTER, and at LESS COST than any other book or course,  
**YOU BE THE JUDGE!**

**ELECTRONICS AND AIR POWER**  
 (Continued from page 27)

clouds again before the gun crews could even get to their A.A. gun mounts.

Torpedo planes once could glide in close to Allied ships at dusk from the night side by coasting down in a long silent glide towards the sea, skimming the waves with throttle low while moving through the mist over the water, slipping a torpedo into the water, banking around and sneaking off into the dusk from which they came. Very often, the crews of such torpedoed ships never did know just what hit them.

Diving out of a bright sun was another favorite trick of plane pilots during the early days of the war. An Allied carrier was caught in the Mediterranean area by a squadron of Nazi Stukas that chose—in typical Nazi strategy—the end of the noon hour to attack. The carrier's crew was down below decks having chow. The Stukas approached the carrier undetected from a great height and dove out of the sun to blast the surprised ship at a rate that cost it 135 men in a quarter hour of man-made, flaming hell. The crew felt the ship rear up and nearly turn turtle from near-hits. They saw beams and bulkheads buckle and flex like rubber plates from direct hits and saw their crew mates blasted into nothingness before their eyes.

Naval units still face a difficult defense problem when a simultaneous multiple torpedo-plane, dive-bomber and a low-level and high-level bomber attack is launched against them. Such a multiple-pronged attack seriously spread-eagles a warship's fire-power. However, there is a saturation point which limits the safe number or "traffic level" of attacking planes which can occupy the immediate area about a warship. With the fire-control systems which modern men-o'-war now possess, even such complex aerial attacks can be successfully beaten off.

Furthermore, many tactical blunders made by inexperienced ship commanders and gunnery officers have now been corrected.

Typical examples of this were the operation of inadequately protected Allied naval units in restricted island waters and anchoring them in harbor bases within range of superior performing land-based planes in the Norwegian, Cretean and Greek campaigns early in the war.

Still another was the careless use of the searchlights and tracer shells during night fighting. Trained pilots can spot a cigaret light hundreds of yards away, to say nothing of illumination lights or searchlights.

Even tracer shells must be used with caution in night fighting. One Allied destroyer was recently damaged seriously with heavy loss of life on a Nazi aerial "sucker play."

Three Nazi planes did the job. Two roared in at the destroyers from opposite sides in a "sacrifice play" move. The destroyer's cannon went into action spitting tracer shells with every fifth shot. Meanwhile, the third plane circled high above the destroyer undetected, in a "sleeper play" stunt.

The destroyer's cannon knocked down the two flank attacking planes, but the "sacrifice play" paid off. The third plane nosed into a steep dive directly into the dark spot at the apex of the brilliant "V" formed by the destroyer's tracer shells. The pilot simply couldn't miss and a heavy egg was laid right smack amidships to tear out the destroyer's middle, wipe out quarter of the ship's crew and nearly sink it.

Another bitter and costly lesson was learned from the Masters at War. More cautious use of tracer shells will be made henceforth during aerial night attacks.

In spite of the increasing dominance of air power and the changes in naval ship design and the adoption of a naval air arm that it has brought about, the war has so far shown the air arm to be merely a new weapon—a long range and highly mobile artillery and not much more.

New weapons may win battles but in themselves do not win wars. That is why the American military men persisted in using the air arm as an auxiliary to the land and naval arms. The war has also vindicated the British contention that the nation that is mistress of the seven seas is mistress of the planet Earth. It is largely seapower and not airpower that has sealed the doom of the Fascist revolution.

However, airpower has brought about one important change in warfare which news commentators have apparently overlooked. Heretofore, the centrally located warring nation had all the military advantages since it had the shortest and internal lines of supply and communication. Airpower has now reversed the picture. The centrally located belligerent is one that now takes the worst beating in an aerial war. The enemy can set up air bases all about it and plaster it unmercifully from the air while its own cities are out of harm's way. Seapower further accentuates this disadvantage.

This is the second part of Mr. Powell's article, which was written last March. In the concluding part, to be published next month, he will "don the traditional Gernsback mantle of prophecy," and make some predictions on the effect of electronics in future military strategy and therefore, on coming chapters of the history of mankind.

### MICRO-SWITCH

A 15-ampere snap-switch no bigger than a small mica condenser is this latest Acro-Snap. Placed behind a postage stamp, only one end and the terminals are visible. Yet the special rolling-spring principle, illustrated in the cut-away drawing, makes it a positive-action switch fully as reliable as those of the larger types.

The complete switch is only 17/64 inch thick, 13/16 inch high and 1 3/16 inch long. There are four small (3/32 inch) mounting holes in the corners of the bakelite case.

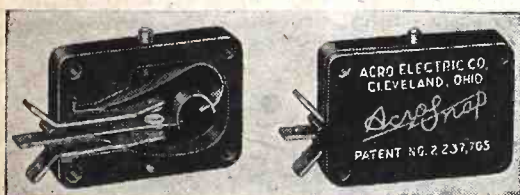

Actuation is with a stainless steel pin plunger. All parts are non-corrosive and all contacts are of fine silver. The main blade, contact blade, and rolling spring are made of beryllium copper. Rated at 15 amps., 115 volts A.C. The switch is furnished in single pole normally open and normally closed, double throw.

The manufacturers, Acro Electric Co., of Cleveland, Ohio, point out that the design is such as to permit leaf type or overtravel plunger type actuators to be attached to the case.

A switch of this type will have a wide range of uses in radio and electronics, but is even more interesting in that it will give our manufacturers of small components a new mark to shoot at.

# These 2 GHIRARDI BOOKS Will help you to Diagnose, Locate and Repair Receiver Troubles EASIER • BETTER and FASTER



ALFRED A. GHIRARDI

Let Radio's foremost instructor guide you!

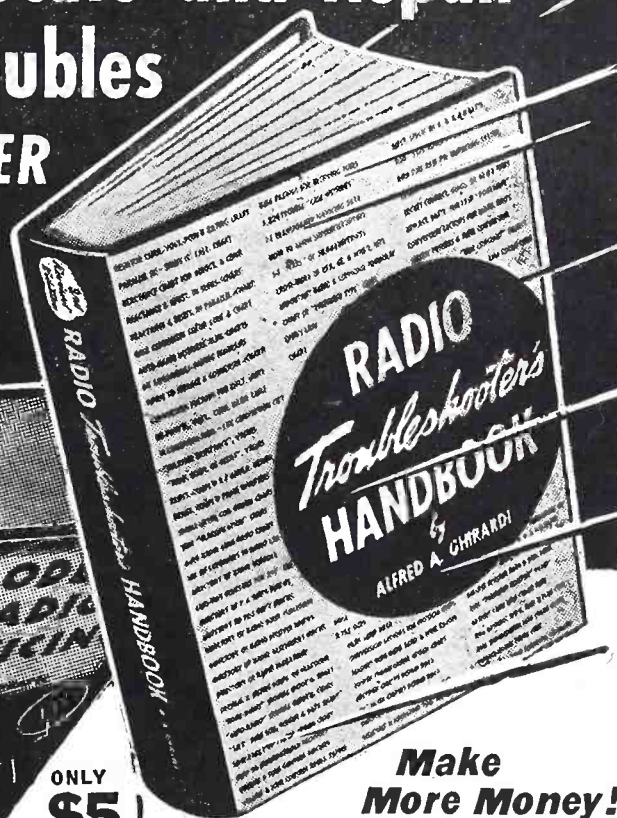

ONLY  
**\$5**  
EACH!

Make  
More Money!

### Ghirardi's Famous MODERN RADIO SERVICING

The book that trains you quickly to MAKE MORE MONEY and get a bigger job as a Radio-Electronic repair technician. BECAUSE it is by far the largest, finest, most easily understood how-to-do it training course on the subject!

"Modern Radio Servicing" is the only single, inexpensive book that gives you a thorough training in the construction and working of all types of test instruments; receiver troubleshooting procedure; circuit analysis; testing, repair, and replacement of individual receiver parts; installation; adjustments, maintenance; service shop management, etc.

#### Test Instruments—Repair—Troubleshooting

No other book can compare with this one for complete, easily understandable instruction on every phase of service work. "I recently finished a course in Radio Repair at one of the N. Y. radio schools and all my learning at this school did not help me to understand and repair radios as quickly as did this one book. I made my money back on one job alone!" writes Henry Miller of Brooklyn, N. Y.

You, too, can get a thorough and practical working training in Radio-Electronic servicing from this famous Ghirardi book—by yourself, in spare time at home—just as Mr. Miller and thousands of others have done. Its 1300 pages and 700 illustrations help you visualize every action. The 720 self-testing review questions help you check your progress. Progress as fast as you want to. It's the biggest servicing training bargain you can buy anywhere. You are protected completely by our

### RADIO TROUBLESHOOTER'S HANDBOOK

744 big pages, chock-full of just the kind of time-saving, money-making, tabulated and charted servicing data that servicemen are finding invaluable.

#### HERE'S HOW TO TEST A RADIO IN 2 MINUTES or less!

Ghirardi's RADIO TROUBLESHOOTER'S HANDBOOK isn't a "study book." It's an on-the-job data book to be referred to in your everyday work. For example, don't waste your time on complicated troubleshooting for every ailing receiver you are called upon to repair! First, look up its model number in the big Trouble Case History Section of the Handbook which lists common troubles and their remedies for over 4,800 models of receivers and record changers.

#### CHOCK-FULL OF SPEED-UP DATA

Nine times out of ten the Handbook will give you the exact clue you need to repair a receiver at once—often without any testing at all! Similarly, on tubes, parts, replacements, substitutions, color codes, circuit alignment, auto radio, batteries, vibrators, ballasts, grid bias resistors, condensers, transformers, tone controls, filters, etc., etc., you get pages of quick-find, tabulated data to help do every repair job better—AND A LOT FASTER! This big new Handbook that weighs over 4 pounds is yours to use every day to make more money for only \$5 complete (\$5.50 foreign) and our Money Back Guarantee protects you. Order today!

## 5-DAY MONEY-BACK GUARANTEE

### MAIL THIS COUPON NOW!

RADIO & TECHNICAL DIV. of Murray Hill Books, Inc., Dept. RC-104, 232 Madison Ave., New York 16, N. Y.

Enclosed find \$..... for books checked or,  send C.O.D. for this amount plus postage (sent C.O.D. in U.S.A. only). If not fully satisfactory, I may return books within 5 days and receive my money back.

- Special MONEY-SAVING COMBINATION — Both books \$9.50 (\$10.50 foreign).
- RADIO TROUBLESHOOTER'S HANDBOOK, \$5. (\$5.50 foreign).
- MODERN RADIO SERVICING, \$5. (\$5.50 foreign).

Name .....

Address .....

City (and Dist. No.) ..... State .....

### SPECIAL MONEY-SAVING COMBINATION

#### OFFER!

Both books for only \$9.50  
(\$10.50 foreign)

A total of OVER 2,000 PAGES of the world's most helpful and profitable servicing information!

REPAIR ANY KIND OF RADIO EQUIPMENT  
PREPARE FOR A BETTER JOB AS A RADIO-ELECTRONIC TECHNICIAN

# New Radio-Electronic Devices

## IMPROVED ATTENUATORS

The Daven Company  
Newark, New Jersey

**A**N IMPROVED line of attenuators, featuring a new detent gear, new materials and new type steel cover, has just been announced.

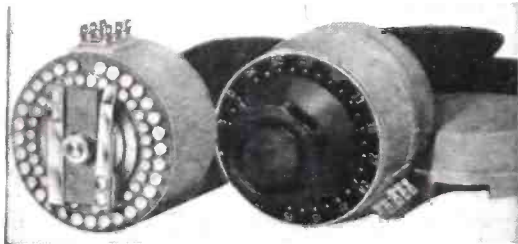

The new Daven detent gear provides more positive action, greater degree of accuracy, more uniformity in operation, longer life and a stronger stop mechanism.

Contacts and switches of these attenuators are made of tarnish-proof silver alloy, giving uniform and definite electrical contact. It should be of interest to note that the cleaning and lubricating of the contact points are now completely eliminated.

The new type steel cover provides improved magnetic shielding. The body of the cover forms an integral part of the attenuator assembly, protecting the resistors. A snap-on cap gives ready access to switch blades and contacts.—*Radio-Craft*

## MEGOHM METER

Industrial Instruments, Inc.  
Jersey City, N. J.

**E**SENTIALLY a direct-reading ohm-meter but incorporating a vacuum-tube voltmeter in order to cover relatively high resistance values, Model L-2 Megohm Meter offers several new features for this type of instrument. In addition to laboratory usage, especially for checking leakage resistance of cables and insulating materials, locating defective insulation in equipment, and measuring carbon resistors, it is readily adaptable to production testing, particularly of radio condensers.

Entirely self-contained, it operates on 110-volt 60-cycle A.C. The instrument is mounted on a sloping panel for convenience in production testing. Arrangements are



provided for the rapid charging of condensers under test. An external battery voltage supply may be used where voltages other than the self-contained 200-volt supply, are desired. The instrument may be satisfactorily operated with external voltages up to 1000.

Internal resistance standards enable the operator to check calibration and make compensating adjustments when necessary. Full length of scale is  $3\frac{3}{4}$ " with less crowding at high-resistance end than is usual in such an instrument. Using the internal 200-volt supply, maximum range extends from 1 megohm to 100,000 megohms in four overlapping ranges but can be extended to 500,000 megohms with an external 1000-volt supply. Maximum resistance in series with condenser or insulation under test is only 1 megohm. This assures practically constant voltage across test terminals and minimizes the effect of tube ground current. Stability is assured by balanced tube circuit and voltage regulators in the internal power supply. The Model L-2 Megohm Meter measures 10" h. x 8" w. x 15" deep, and weighs 10 pounds.—*Radio-Craft*

## IMPULSE-INITIATED TIMER

Struthers-Dunn, Inc.  
Philadelphia, Penna.

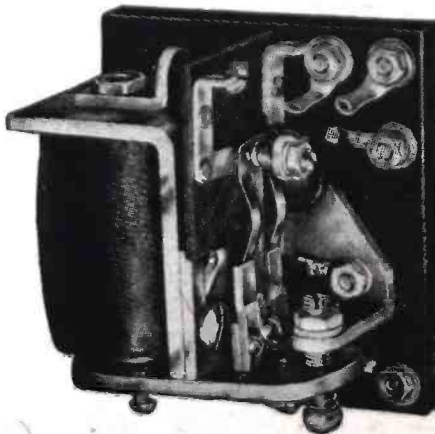

**T**HIS new impulse-initiated timer is 71.8% smaller by volume than previous conventional units used for similar applications. The new timer has the added advantages of rugged, shock-proof construction, easily-accessible contacts, and dustproof cover.

Known as the Struthers-Dunn Type PSEH-1, it is made in both A.C. and D.C. types. Contact operation occurs at the end of a delay interval after power has been applied, or after receipt of a momentary impulse from a push-button, limit switch, or other source. The adjustable timing range is 20-to-1, and the mechanism is immediately recycling.

A built-in double-pole, double-throw auxiliary relay provides a variety of circuit arrangements common to, or isolated from, the control circuit.

Type PSEH-1 Timers can be supplied for A.C. operation on 110-volt 60 cycles or 25 cycles; 220-volt 60 cycles or 25 cycles; or for D.C. operation at any specified voltage from 6 to 120 volts. Size of a typical unit is  $3\frac{1}{2}$ " x  $3\frac{3}{8}$ " x  $3\frac{3}{4}$ ".—*Radio-Craft*

## WIRE-WOUND CONTROL

Clarostat Mfg. Co.  
Brooklyn, N. Y.

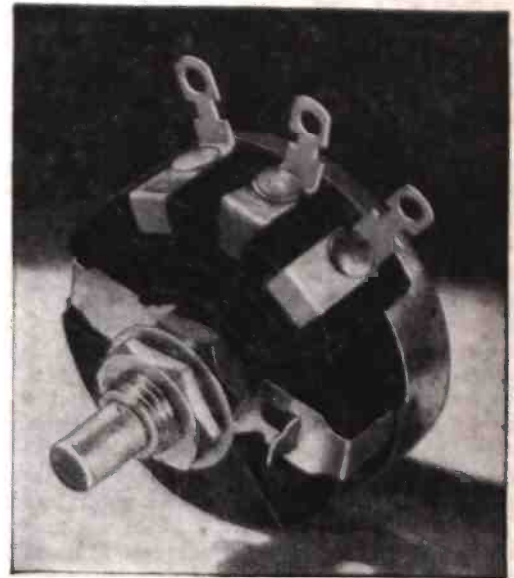

**T**HE Type 58 Clarostat wire-wound potentiometer or rheostat is a tougher control fully capable of coping with extreme vibration and mechanical abuse such as encountered in wartime service.

The new design differs somewhat from the previous Type 58. A metal strap on the shaft face provides for the two-position locating pin which cannot break or tear off. Also, the metal strap grounds the metal cover which is clinched to it. The cover is keyed in place on the casing and therefore will not loosen or turn. Fully dustproof. The bushing is keyed into the bakelite case and therefore cannot slip or turn when the locking nut is drawn up tightly. High-grade molded bakelite can eliminate corrosion and electrolytic action especially when control is used on D.C.

There is zero hopoff at terminal. 1500-volt breakdown insulation between winding and shaft. Switch can be added. Minimum depth. Tandem units with two or more controls on common shaft, are available. Ratings: linear, 3 watts; V and W tapers, 2 watts; L, N and U tapers, 1.5 watts. Resistance values: linear, 1 to 75,000 ohms; tapered, 10 to 50,000 ohms.—*Radio-Craft*

## ELECTRICAL CONNECTOR

Cannon Electric Development Co.  
Los Angeles, Calif.

**N**EWEST CANNON electrical connector in the Army-Navy Specifications line is the type known as AN3101, according to the proposed AN-W-C-591a specifications. Although in general appearance this new type looks like a plug, it has been designated as a "receptacle" inasmuch as it has a male coupling thread similar to Types AN3100 and WN3102.

AN 3101 is a mating cord connector for AN 3106 and AN 3108. Since it has no mounting facilities such as the flange on Types AN 3100 and AN 3102, it may be used in place of an AN 3100 or AN 3102 when regular mounting is not necessary. Also adaptable for an extension cord.

—*Radio-Craft*

# SPRAGUE TRADING POST



## A FREE Buy-Exchange-Sell Service for Radio Men

**The ONLY Resistors wound with \* CERAMIC INSULATED WIRE!**

\* FLEXIBLE

\* MOISTURE-PROOF

\* HEAT-PROOF TO 1000°C.

\* LARGER WIRE SIZES IN LESS SPACE



As a radio serviceman, no one has to tell you that a wire wound resistor is no better than its insulation—or that that is why Sprague KOOLOHM Resistors are "tops" by any test you care to name. KOOLOHM ceramic insulation is applied directly to the wire and the assembly is then DOUBLY protected by an outer ceramic tube. KOOLOHMS operate so cool you can use them at full wattage ratings. They are highly resistant to both moisture and heat. They give you higher ratings in smaller sizes. KOOLOHMS will not let you down!

**WANTED**—Condenser checker—Aerovox L.C. No. 95, Sprague Tel-O-Mike, Cornell Dubilier B.F. 50 or Solar C.C. or C.B. John Lough, Carol Radio, 111-15 Wiltthoff St., Queens Village 9, L. I., N. Y.

**FOR SALE**—Rider manuals 1-5 in new condensed volume, and 6 to 12 inc., all in original cartons, practically new. \$85. Cogill Radio Service, 616-6th Pl., S.E. Mason City, Iowa.

**FOR SALE**—Readrite service test oscillator No. 550, covering intermediate and broadcast bands \$10; also D.C. power packs, producing 1 1/2 v. "A", 90v. "B", 2 v. "A", and 135v. "B", \$5 each. Joseph Anderson, R. F. D. No. 1, Box No. 47, New Sweden, Maine.

**WANTED**—510X Hickok, RCA voltohmyst, in perfect condition; also 12SA7, 12SK7, 12SQ7, 12A8, 35Z5, 35Z3, 35Z4, 35L6, 50L6, 117N7, 117L7 tubes. H. E. Binning, 23638 Wilson Ave., Dearborn, Mich.

**FOR SALE**—Superior sig. generator G.N.T. 6 bands, 100 KC to 2200 KC. 2.2 MC to 105 MC. A.F. or R.F., audio frequency 25 to 10,000 cycles, \$35. Want Rider manuals 1, 2, 6, 7, 8, 9, 10, 11, 12 and 13; also Simpson 0-1 Ma. No. 27 meter scale for V-O-M. meter. John E. Thiel, 742 N. Denver, Tulsa 6, Okla.

**WILL TRADE**—807 tubes 100TH, 866 Sr. or crystals. Want aut. RCA record changer, and 35 L6, 35Z5, 35Z4, 50L6, 117L7, 1A7, 1H5, 1N5 tubes. S/Sgt. George W. Hodges, 503 E. 7th St., McCook, Nebr.

**WILL SWAP**—N.R.I. code nacometer with built-in oscillator, 3 tapes (others available). Want late model all-wave sig. generator, set analyzer, and test speaker, variable ohm taps, in good condition. Edward D. Sharlow, 1344 Eastland Ave., Akron, Ohio.

**URGENTLY NEEDED**—Good amplifier with mike and phono inputs, using 6L6's. Ralph Lore, 712 Sycamore St., Rocky Mount, N. C.

**WANTED**—Up-to-date sig. generator. Guy P. Jennings, 230 Washington Ave., Covington, Va.

**WANTED**—Multi-wave coil assemblies or tuning units—Meissner units with r.f. det., and oscillator coils, or equivalent. Must be A-1. Ernest A. Kampe, 5221 S.W. 8th St., Miami, Fla.

**FOR SALE**—Gang condensers, small trimming and tuning condensers, coils, audio transformers, enamel wire, dials, and other radio parts. L. Bruckner, 7511 Lehmer St., Forest Park, Ill.

**FOR SALE OR TRADE**—A quantity of wanted tubes at 40% off O.P.A. list. What do you need? Want P.A. system and 16 MM. movie camera. C. H. Rhodes, Box 57, Armbrust, Pa.

**WANTED**—Hallicrafters No. 27 FM-AM Tuner, tuning from 28 MC to 145 MC, or similar FM tuner. Al Birch, P.O. Box 13, Parkland, Wash.

**URGENTLY NEEDED, FOR CASH**—16 MM sound projector, 60 cycle; also 110V A.C. generator. Courneya Radio Sales, Tweed, Ontario, Canada.

**WANTED**—Haydon timing motor, 115v. 60 C.A.C. 5 R.P.M.; prefer left hand rotation. Sheldon W. Gates, 1717 Forbes Ave., St. Joseph, Mich.

**WILL SWAP**—New Simpson 5000 ohms per volt V-O-M for small modern mantel radio in good condition. Geo Choulnard, 4599 Papineau Ave., Montreal, Canada.

**WANTED**—Multiple volt ohmmeter; also new or slightly used tubes. Jack Musu, 206 E. 40th Street, New York 16, N. Y.

**URGENTLY NEEDED**—A-C or D-C meters, test equipment, radio parts, etc. Otis Q. Statts, Houghton Park Village, House 336, Blk. Q. N. Long Beach, Calif.

**WANTED**—Complete set Rider manuals, test equipment and tubes. Edward Cavorotto, 317 Chestnut St., San Francisco, Calif.

**FOR SALE OR TRADE**—Miscellaneous tubes and neon test lamp. Urgently need tube tester, V-O-M, sig. generator, scope. Seth Kellogg, Box 945, El Centro, Calif.

**WANTED**—Multimeter—also sig. generator. John T. Hayes, 600 Washington Ave., Merchantville, N. J.

**WANTED**—Battery and AC midget radios. Will buy or swap. What do you want? John Haynes, Doe Run, Missouri.

**FOR SALE OR SWAP**—A number of wanted tube types. What have you? H. B. Reynolds Radio & Equipment, 719 Stone St., Oneida, N. Y.

**WANTED**—Sky Buddy com. receiver, late model tube tester and small P.A. amplifier. Paul Evanosky, 184 Zerby Ave., Edwardsville, Pa.

**URGENTLY NEEDED**—Sig. generator in good condition. Dynako Radio Ser., Punxsutawney, Pa.

**FOR SALE**—Webster 4L35 35 watt amp., 30 watt booster amp; Hickok output meter; Cinaudagraph HWA units with SW horns; University PAH unit with LH horn, Shielded 200 ohm to grid line trans; 55B Shure Unidyne; RCA 50-A inductor mikes with floor stands; Brush B1 hand mike, wire shielded mike cable with Amphenol connectors; Oxford 12" dynamics with horns. All like new. Johns Radio Shop, 32 Maple St., Perry, Ohio.

**WANTED**—All-wave sig. generator, multi-meter from 10,000,000 ohms—10 megohms, tube tester with instruction sheets (if possible). Donald Vigo, Box 88, Tarriffville, Conn.

**WANTED**—Late model tube tester and Rider manuals. Raymond Papineau, 725 N. Rockhill, Alliance, Ohio.

**FOR SALE OR SWAP**—Clough Brenglo OCA all-wave sig. generator; Dayrad Raytheon No. 92 tube tester; Potter A. Condenser tester; Race electric motor hair clippers; Eastman 3A folding camera. Want short wave receiver. Glenn Watt, Chanute, Kans.

**FOR SALE OR TRADE**—Hallicrafters Sky Champion receiver, slightly used. Want Rider chanalyser or Hickok Trace-O-Meter; also 2-50Y6 tubes. W. M. Ogletree, Barnesville, Ga.

**WANTED FOR CASH**—Sig. generator and multimeter in A-1 condition. William Stetson, 60 Pine St., Struthers, Ohio.

**FOR SALE OR TRADE**—Supreme tube tester No. 35, with blue prints to make adapters and charts to bring set up to date. \$18. Want good sig. generator or what have you? Craft's Radio Shop, 202 N. Fourth Ave., Marshalltown, Iowa.

**WANTED**—Sig. generator, multimeter, and tube tester for all late tubes. Cecil Hinesman, R.F.D., Rudolph, Ohio.

**WILL SWAP**—Snare drum and sticks for set analyzer or tube tester. Ed. Johanson, R.F.D. No. 1, Monticello, N. Y.

**URGENTLY NEEDED**—A-C power pack for battery portables, 90v. Joseph Sidelko, Jr., 411 Bennett St., Luzerne, Pa.

**FOR SALE**—Weston 414-0-100 galvanometer, \$10. Herman Shuyter, 114 S. Hayford Ave., Lansing 12, Mich.

**WANTED**—Rider manuals; also 35L6, 35Z4, 6A8 and other tubes. What have you? Gilbert R. Seybold, 107 West Westmoreland Road, Falls Church, Virginia.

**WANTED**—Carbon mike and photo-electric cell. Alex Bell, Wooler, Ontario, Canada.

**WANTED**—V-O-M multimeter, tube tester and sig. generator. Must be A-1. T. C. Banks, 2 Croatan Rd., Havelock, No. Car.

**FOR SALE**—Weston 547 multimeter, like new. Want No. 50 GE recorder, new or used, with extra spool of recorder wire. Hammond Mathews, Drawer H, Silverton, Colorado.

**FOR IMMEDIATE SALE**—16-watt amplifier in cabinet, almost new; also mike and phono, \$26; and Bruno PA-3 mike, 50' cable, \$9.95. E. H. Munn, Jr., 306 N. West St., Hillsdale, Mich.

**WANTED**—FB7 or FBXA with coils. Stephen A. Lengiel, 550 S. 2nd St., Steelton, Pa.

**FOR SALE**—Webster amplifier, complete with speakers, microphone, etc.; also radio repair instruments, late model tube checker. Readrite 710 analyzer, tube assortment, condensers, etc. S. F. Freeman, Box 241, Whitmire, S. C.

**WILL EXCHANGE**—D.C. voltmeter for A.C. voltmeter. J. J. Gelles, Jr., P.O. Box 70, Brunswick, Ga.

**URGENTLY NEEDED**—Triplet (726) 7" meter in either 50 microamperes or 1 ma. movement; also Triplet No. 1183 combination analyzer, multimeter, tube-tester. B. F. Goldberg, 2808 River Drive, Columbia 37, S. C.

**WANTED**—Condenser and resistor checker. Must be A-1. Althaus Radio Service, 601 Carpenter St., Columbus 5, Ohio.

## YOUR OWN AD RUN FREE!

This is Sprague's special wartime advertising service to help radio men get needed parts and equipment, or dispose of radio materials they do not need. Send your ad today. Write **PLAINLY** or **PRINT**—hold it to 40 words or less. Due to the large number received, ads may be delayed a month or two, but will be published as rapidly as possible. We'll do everything we can to help you. Remember that "Equipment for Sale" ads bring best results.

Sprague reserves the right to reject ads which do not fit in with the spirit of this service.

When buying Capacitors—please ask for Sprague's by name. We'll appreciate it!

HARRY KALKER, Sales Manager

**SPRAGUE PRODUCTS CO., DEPT. RC-104, North Adams, Mass.**  
(Jobbing distributing organization of products manufactured by SPRAGUE ELECTRIC COMPANY)

# SPRAGUE CONDENSERS

# \* KOOLOHM RESISTORS

Obviously, Sprague cannot assume any responsibility, or guarantee goods, services, etc., which might be exchanged through the above advertisements.

\*TRADEMARK REG. U.S. PAT. OFF.

# THE QUESTION BOX

## TWO-TUBE S.W. RECEIVER

**?** Will you please design me a two-tube receiver using one 1N5 and one 1Q5? A set that will bring in distant stations, with smooth control of regeneration, is required.—A.H., Thompson, N. D.

**A.** The modified Hartley shown here will meet your requirements. Ordinary broadcast and short-wave plug-in coils may be used, with the tap made from 10% to 25% of the way up from the plate end. Experiment to get the best point.

## TUNED R.F. RADIO

**?** Please supply a circuit for an A.C.-D.C. radio receiver using a 77, 78, 37, 38 and a 25Z5. Two stages of R.F. are required.—J.G., N. Y. C.

**A.** The circuit requested is drawn. While your tube complement is not too suitable for a receiver, by putting the volume con-

trol in the circuit of the second tube and using the 77 as first R. F., a fairly efficient set may be made. If two 78's were available, the volume control would be better in the cathode circuit of the first tube.

## AMPLIFIER FROM A-K 39

**?** I have an old Atwater-Kent AK-36 radio and wish to make an audio amplifier out of it. This would be for playing records, a crystal pickup being used.—E.W.H., Birmingham, Ala.

**A.** A circuit suitable for converting the detector and audio end of the AK-36 (or almost any other radio of the same period) into an audio amplifier is shown. Volume must be kept rather low if distortion is to be avoided, as the output tube and speaker are not capable of giving as much output as is now considered desirable. These old amplifiers are chiefly useful for intercommunicators, or in applications where high-fidelity music reproduction is not required.

## TWO-IN-ONE RECEIVER

**?** Will you please draw me a circuit for a radio receiver using only one tube, which can be used with a ground connection only and no aerial? I want to use this as a portable, and would like to have one that would work with 45 volts.—H.H., Hartford, Conn.

**A.** A circuit of the type you require can be made with the help of the 1G6-GT tube. The circuit is shown. An ordinary 4-prong plug-in coil can be used, or you can wind one experimentally, on a smaller form, if you want a more compact set. Because the set is to be used with low voltage a small audio choke is used in the detector plate. If more than 40 volts is used it may be found better to tap the detector plate off at 45 and use the higher voltage on the audio tube only. Using an aerial and adding a ground will improve the sensitivity of your set, as will connecting the aerial post to any large metal object, such as a bed-spring or piece of metal furniture.

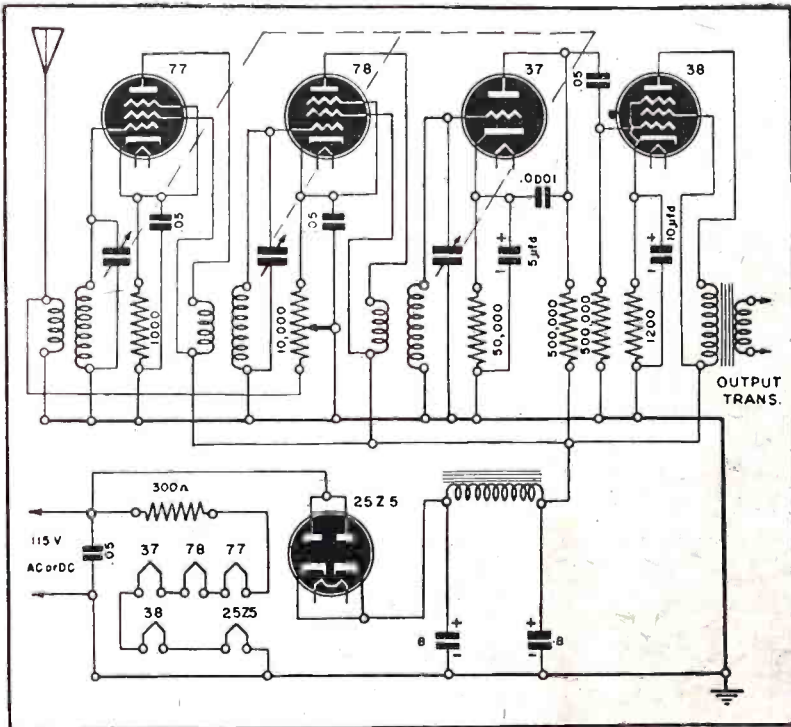

Top left—A 5-tube tuned R.F. receiver from old radio parts. Bottom left—A 2-tube short-wave receiver with plug-in coils. Top right—2-in-1 receiver. Bottom right—3-stage amplifier constructed from an old Atwater-Kent 39.

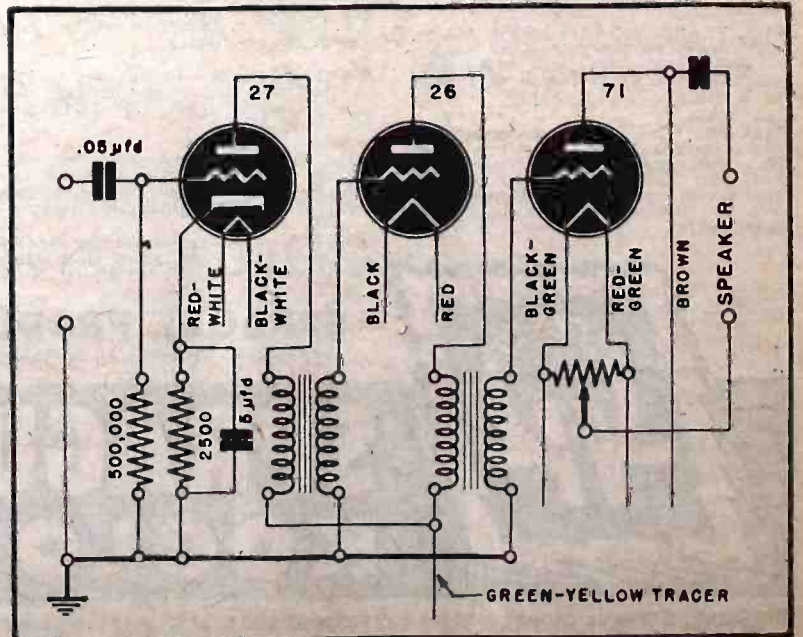
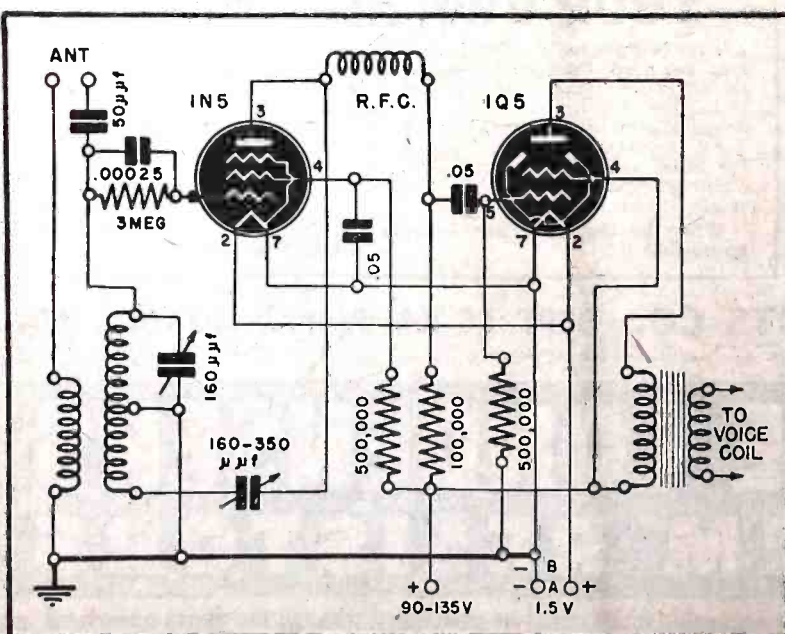
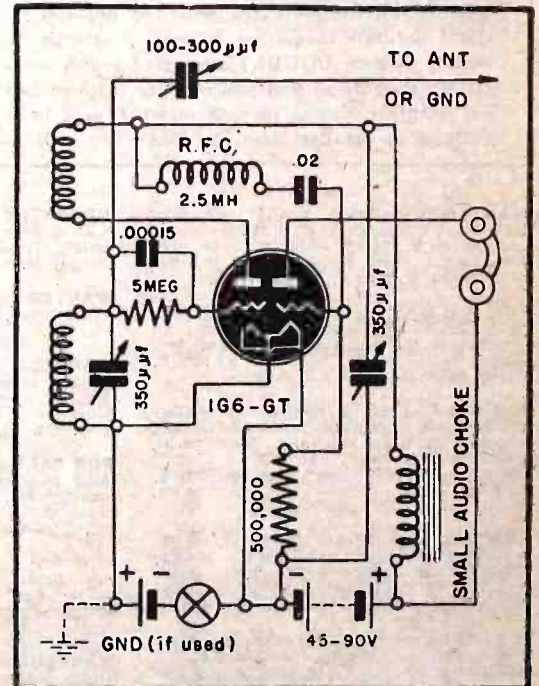



HE'S NO NATIVE. HE FOLLOWED HOGARTH FROM HARLEM BECAUSE OF HIS **ECHOPHONE EC-1!**

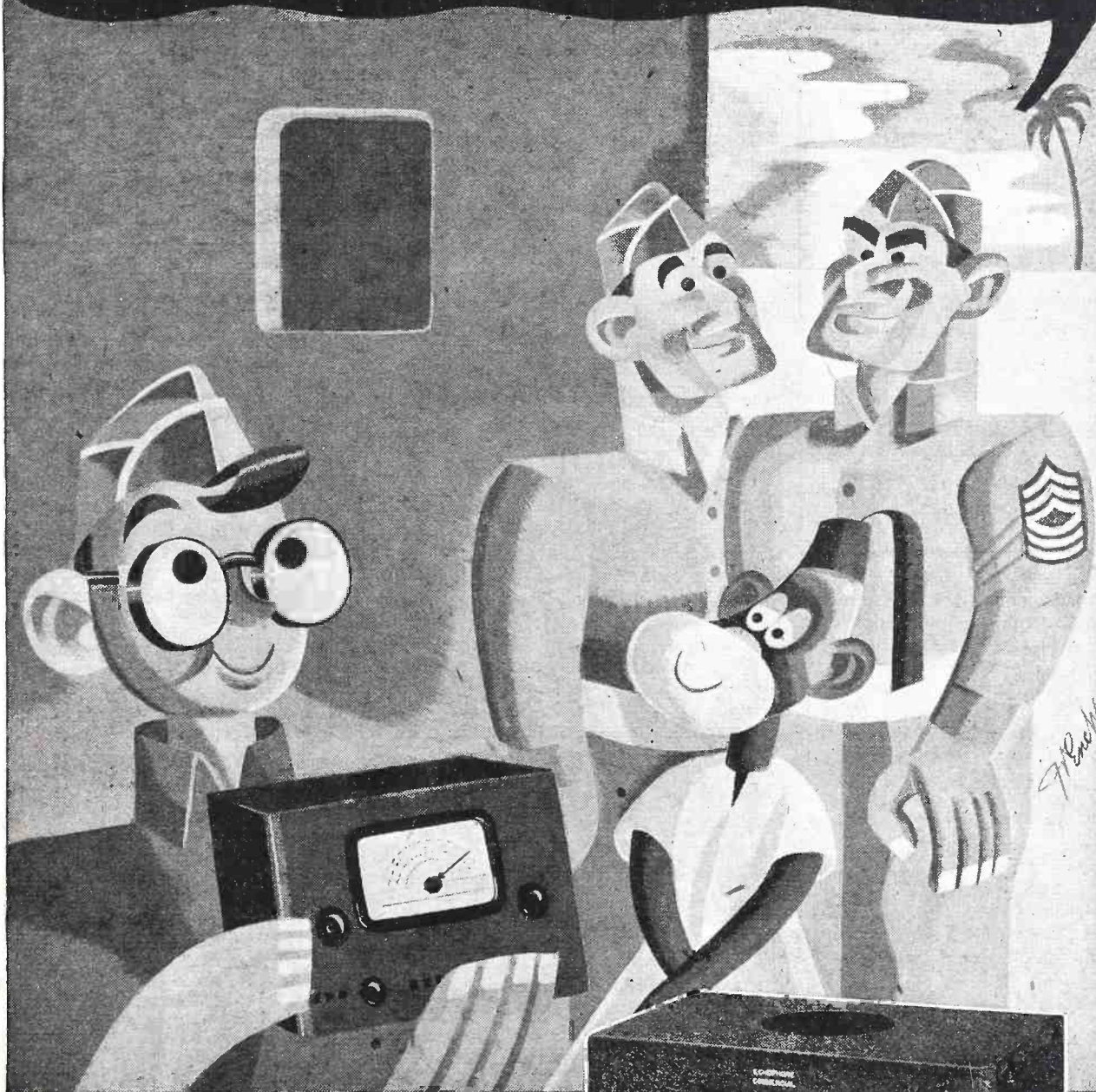

### **ECHOPHONE MODEL EC-1**

(Illustrated) a compact communications receiver with every necessary feature for good reception. Covers from 550 kc. to 30 mc. on 3 bands. Electrical bandspread on all bands. Six tubes. Self-contained speaker. 115-125 volts AC or DC.



**ECHOPHONE RADIO CO., 540 NORTH MICHIGAN AVE., CHICAGO 11, ILLINOIS**

# TRY THIS ONE!

## ODD-SIZED RESISTORS

If you need, let's say, a 10 Watt 330 Ohm Resistor, look for one of approximately the same wattage, for example, a 300-ohm or as close as you can get to the desired resistance. (The resistor must be of the insulated type.) Get from a burnt out wire resistor a piece of wire. Wind it securely around one of the ends of the resistor, make a tiny clamp with a little screw and two small nuts; clamp the wound wire to the resistor terminal with said "clamp."

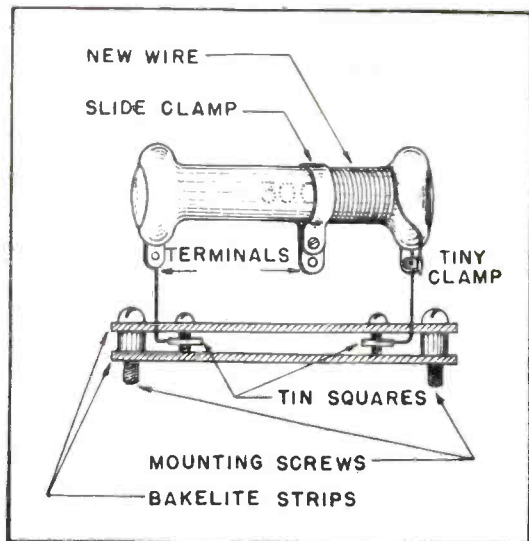

Wind over the same resistor the amount of wire required to satisfy your needs, then put over the new terminal a previously fixed slide clamp from a discarded resistor, and . . . Oh, yes! A mounting. Solder two little squares of tin or brass sheet to the wire points of the resistor. Get two strips of bakelite or other similar material. Make two slots in one of the strips to receive squares and wire, bend wires properly. Drill two holes on strips of bakelite so you can mount on chassis.

I don't think that this is a new idea but I haven't seen it published.

GILBERTO GARZAG,  
Cerro Azul, Ver. Mexico

## HOME-MADE DIAL PLATES

I am submitting the following idea for making dial plates for the home constructor. Such plates can be made by having a photographer make a negative of a dial plate which has been drawn with ink on heavy paper. It has the advantage of being easy to keep clean and also makes a neat looking job. I used such a plate on a condenser tester described in *Radio-Craft*.

In order to make the job of making the negative easier be sure and use white paper and black ink. This will save trouble for the photographer as even slightly colored paper is sometimes hard to photograph. After the negative has been made, cement a piece of white paper on the instrument for a background. Then cement the negative over this. The graduations will show up in good shape.

To get the proper setting on the new plate use one of the standards used in calibrating the original dial plate. Without the pointer in place turn the control to the proper indication for this standard and now apply the pointer in the proper position on the dial plate and tighten it; being careful not to

move the control while so doing. Of course all other graduations will line up perfectly.

T. J. PITMAN,  
Dewey, Oklahoma

(The Editor has used reversed photographic prints for dials with good effect. Where only one dial is required, the celluloid negative should be an improvement.)

## EFFICIENT LINE FILTER

I have used the line filter illustrated with excellent results. The two chokes CH are 10 turns each of No. 14 Enamel wire wound on a form 1/2 inch in diameter. C1 and C2 are 0.1 condensers, 600-volt rating, of good quality. Sometimes the ground is necessary — often results are better without it.

The other day a friend complained that the static in his office was so terrible that he couldn't pick up WEA. I gave him a filter and he reports that the noise has all disappeared.

LOUIS DE BOTLARI, JR.,  
Baldwin, N. Y.

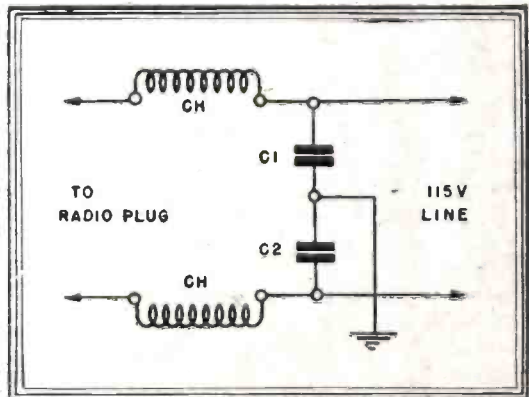

## TWO-USEFUL KINKS

1. Emergency Phillip's Screwdriver. A helpful substitute for a screwdriver for Phillip's screws is a nail with part of the point filed off. A slot in the nail will adapt the latter for use with a screwdriver.
2. Indoor Antenna. A mass of steel wool, slightly pulled apart, makes an excellent indoor antenna.

BILL BUEHRLE, JR.,  
Ferguson, Mo.

## EASY MULTIPOINT SWITCH

An inexpensive solution to the problem of multipoint switches may be found by using a regular bakelite socket of the wafer type. A standard midget plug may be used as shown in the illustration, or a plug may be made with a tube prong. Phone tips work well in octal sockets.

This method can be used wherever a single-gang, multipoint switch is required.

PAUL BARAN,  
Philadelphia, Penna.

## GOOD PHONE CONNECTION

Here is a diagram that may be of interest to some of your readers. It is a simple and convenient way of coupling phone reception into the output circuit of almost any radio. First, break one of the leads between the output transformer and the voice coil, and insert a S.P.S.T. switch. This may be

toggle or may be connected to a switch in the phone jack. The coil should be from 50 to 75 turns of No. 30 enamel wire, and should be wound around the output trans. The coil should be wound parallel to the windings of the transformer, and brought directly to the phone jack which may be mounted to the back side of the chassis.

JOHN VANCE,  
Upland, Indiana

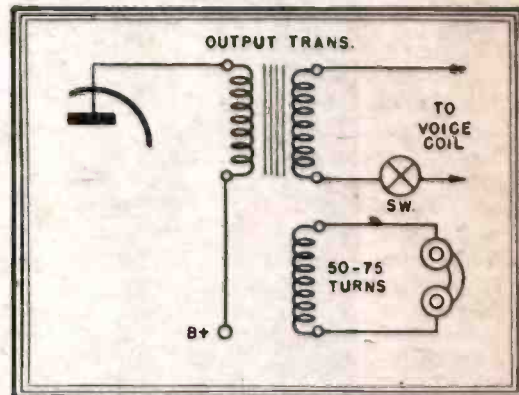

## UNIQUE CRYSTAL DETECTOR

A single disc from a dry kuprox battery charger makes an excellent "Crystal Detector." Use the copper oxide disc as the crystal and a piece of carbon or old motor brush as a cat's whisker.

The carbon should be about 1/4" thick and held to the copper oxide side of the disc with moderate pressure. I use a wooden spring type clothespin. I'd like to see someone beat this for all-around performance.

L. E. SHEPARD,  
Toledo, Ohio

## JUNK-BOX MILLIAMMETER?

With the meter shortage as it is, I believe this idea can be used to advantage by many servicemen and experimenters. It consists of the coil and deflecting vane of the old-type shadowgraph.

A pointer should be soldered to the vane and bent to the left, since the vane would otherwise stop at mid-scale. Calibrate the new meter with known voltages, glue on a white cardboard scale, and with the proper series resistances or shunts, several types of voltmeters or milliammeters may be obtained.

DAVID LINKER,  
Brooklyn, N. Y.

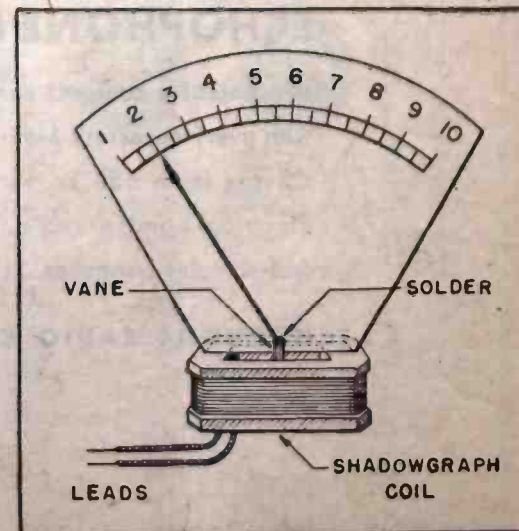

**NEW EDITION  
NOW READY**

# Audels RADIOMANS GUIDE

*Includes* **TELEVISION  
AND ELECTRONICS**

**LARGER - MORE COMPLETE - 914 PAGES - 633 ILLUSTRATIONS - WIRING DIAGRAMS - PHOTOS**



**Specimen cut showing  
BROADCASTING PRINCIPLES—one  
of 400 DIAGRAMS, CHARTS & PHOTOS**

**THE KEY TO PRACTICAL  
RADIO  
INFORMATION**

It gives you in usable form pointers on radio, including frequency modulation, television, etc. Also valuable inside information for Aviators, Marines, Commercial Operators and Technicians, Servicemen and Students.



**Q AND A  
UNIQUE  
QUESTION  
and  
ANSWER  
METHOD**

*Highly Endorsed*

**38 BIG CHAPTERS**

*Easy to Read - Easy to Grasp - Easy to Apply*

A home-study course—especially well organized. The style is so interesting you will read along without effort, hardly realizing that you are actually studying and taking in vital information. Audels Radiomans Guide gives you just the right amount of mathematics required to cope with radio problems successfully. You can solve, with the aid of this extraordinary book, practically every radioproblem that comes up. At your fingertips is a complete index for instant use.



**1001 RADIO FACTS AND FIGURES  
A Complete Library In One Book**

AUDELS RADIOMANS GUIDE gives authentic Principles and Practices in Construction, Operation, Service and Repairs. Covers clearly and concisely radio fundamentals—Ohm's Law—Physics of sound as related to radio science—Measuring instruments—Power supply—Resistors—Inductors—Condensers—Transformers and examples—Broadcasting stations—Radio Telephony—Receivers—Diagrams—Construction—Control Systems—Loudspeakers—Antennas—AutoRadio—Phonograph Pick-ups—Public Address Systems—Aircraft and Marine Radio—Radio Compass—Beacons—Automatic Radio Alarms—Short Wave—Coil Calculations—Testing—Cathode Ray Oscillographs—Static Eliminations—Trouble Pointers—Underwriter's standards—Units and tables. REVIEW QUESTIONS—READY Reference Index.

**7 DAYS' FREE TRIAL**

**\$4 COMPLETE**

**\$1 PAY ONLY**

**1 MO.**

THEO. AUDEL & CO., Publishers  
49 West 23rd Street, New York 10, N. Y.

Mail AUDELS NEW RADIOMANS GUIDE for free examination. If O. K. I will send you \$1 in 7 days; then remit \$1 monthly until \$4 is paid. Otherwise I will return it.

Name \_\_\_\_\_  
Address \_\_\_\_\_  
Occupation \_\_\_\_\_  
Reference \_\_\_\_\_

**MAIL THIS  
COUPON  
TODAY**

# Radio-Electronic Circuits

★ Prize Winners In Signal Generator Contest ★

FIRST PRIZE \$5.00—GERALD A. CHASE

HONORABLE MENTION—SGT. W. G. BARRETT, WILLIAM B. THORNE,  
MILTON NEWSOM.

## THE CHAMPION

I have built the following signal generator and have been getting excellent results from it in connection with my service work. The complete set measures approximately 13" x 8" x 5" deep. Parts and tubes available were used. The miniature tubes cut down current consumption and bring the generator up to operating temperature quickly.

Because only 25-cycle current is available here I used full-wave rectification. Plate current to the two tubes totals less than the four mils maximum rating per 6H6 plate. A 500,000-ohm resistor decreases the 1A7GT plate current and also prevents overmodulation.

The 6H6 filament transformer was originally an output transformer designed to match two 2A5's in push-pull. The secondary was rewound to provide 6.3 volts (in this case 200 turns of No. 26 DSC wire). The low ripple of the filter provides a clear audio note. The audio input jack enables me to use a wireless record player for modulation.

Plug-in coils on Hammarlund forms comprise the R.F. oscillator coils. A total of 225 turns of No. 35 DSC wire tapped at 80 tunes from about 300 to 800 Kc. The tuning condenser is a straight-line frequency type which can be easily calibrated. I use collo-dion to keep the coil in place and keep out moisture.

The IN5G is used to isolate the generator from the output. It is also advisable to shield the attenuator and output leads to prevent direct pickup. Wiring of the R.F. section should be done with fairly heavy wire for a steady frequency and output and the entire instrument should be shielded to avoid radiation. This is a dependable and stable all-wave generator.

GERALD A. CHASE,  
Princeton, Ontario

(Because of its completeness, excellent design, and the fact that the tube line-up is so chosen as to show that any tubes can be used, we believe that this entry merits first prize, though the second is close behind it!)

## A GOOD 2-TUBER

I have constructed this all-wave signal generator and it gives good, accurate signals, both modulated and unmodulated. The power supply may be 250 volts, well filtered. By allowing the generator to warm up before using, little drift will be encountered.

The 6A8 is used as a negative resistance type audio oscillator, the inductance of the choke determining frequency range. The three pole switch allows choice of three modulation tones. I used coils from an old R.F. generator which had a 12SA7 oscillator, the low-frequency coils being made

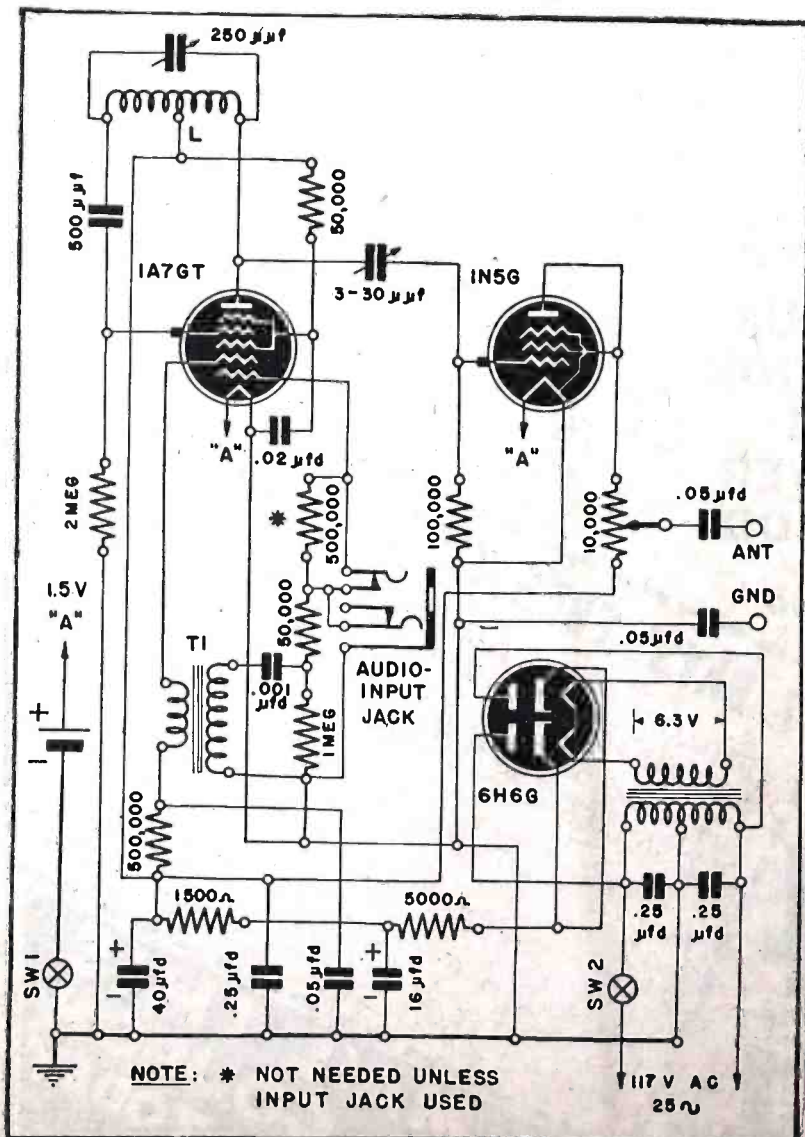

Left—The No. 1 signal generator uses a buffer stage between oscillator and output. Top right—An easily thrown-together one-tube. Bottom right—This two-tube circuit employs a transitron oscillator in the audio section.

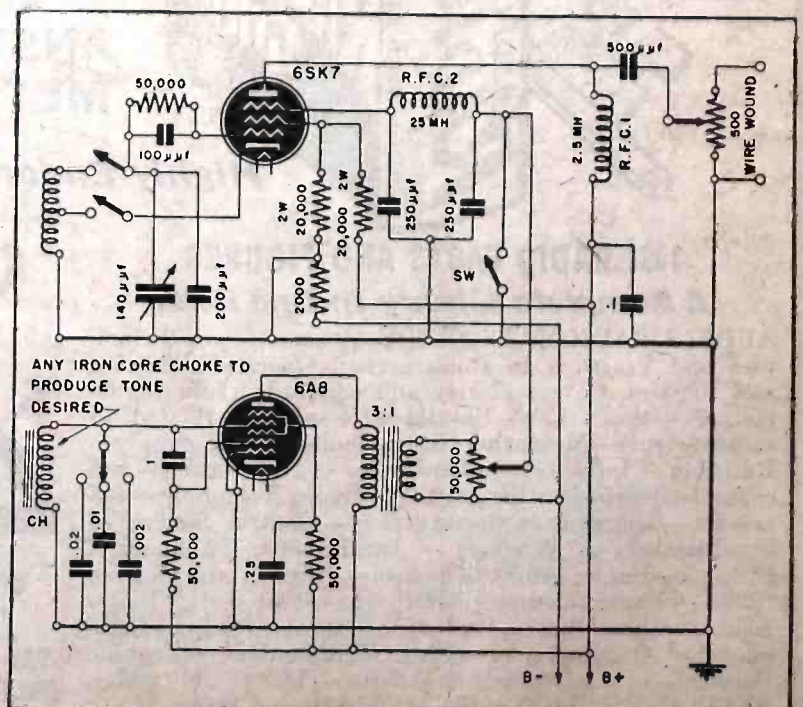
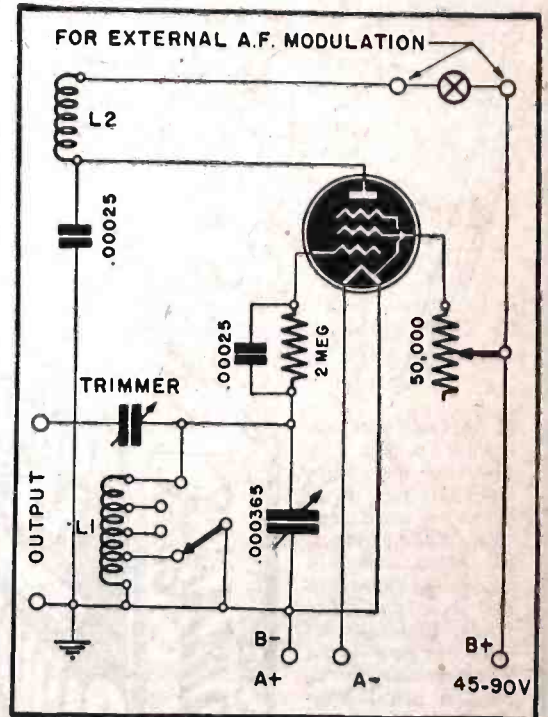

up from 2.5 mh. chokes and windings from I.F. transformers.

This type of oscillator allows the use of harmonics if desired. At low power harmonics are greatly decreased. The 6SK7

suppressor circuit switch is opened when a modulated signal is desired. Otherwise the audio oscillator output is shorted to ground.

SGT. W. G. BARRETT,  
Colorado Springs, Colo.

### SIMPLE ONE-TUBE GENERATOR

Here is a very simple, compact generator, the tube may be a 30, 1C5G, 1A5G, 1S4, etc. Small batteries may be used for A and B supplies. Modulation may be applied to the A.F. posts.

Coils are wound as follows:

L1—93 turns, No. 30 enameled, diameter 1 1/4", tapped as desired.

L2—53 turns No. 30, diameter 1 1/4" on same form, separated by 7/16".

MILTON NEWSON,  
Lumberton, N. C.

### A GOOD A.C.-D.C. MODEL

This signal generator complete with power supply has been giving me very satisfactory results. Constants are given. Good shielding prevents radiation and it is advisable to use grommets in all lead outlets.

The coils were wound of No. 32 enamel wire on 1 1/2 forms, and tapped as shown in

the diagram which is printed just below.

The cabinet should not be grounded to the chassis to avoid danger of short circuit.

The simplest way to calibrate the oscillator is against a well-aligned receiver.

WILLIAM B. THORNE,  
St. John, New Brunswick

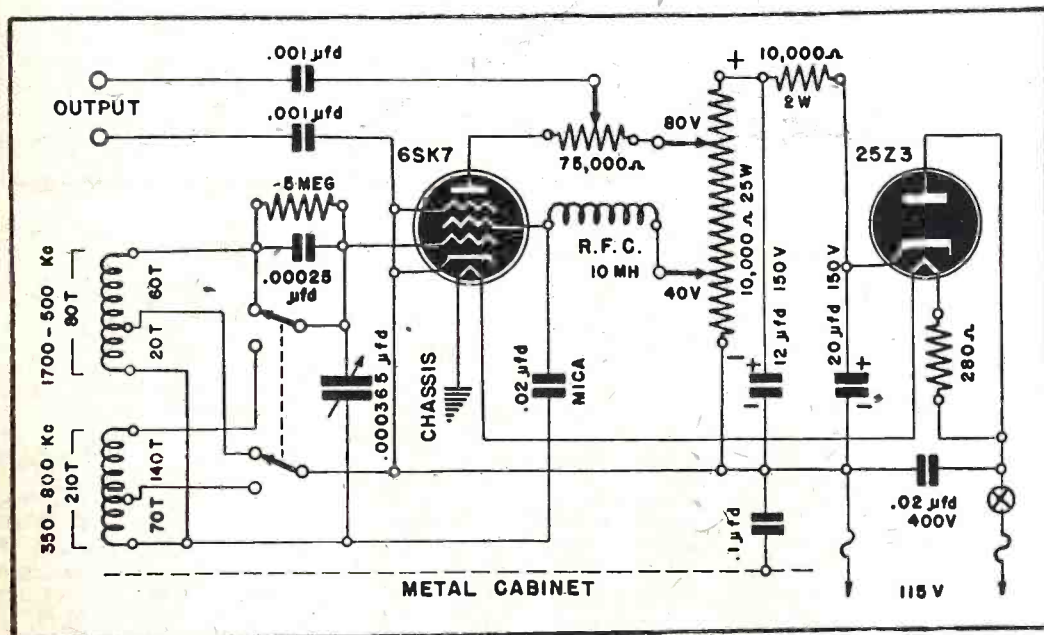

### OSCILLOSCOPES IN INDUSTRY

(Continued from page 23)

movements due to those vibrations observed can be interpreted as follows: In those cases where high-frequency is present due to brush contact and no amount of adjustment will improve the performance, the interfering frequency can be determined by aid of the oscilloscope and an appropriate filter network can be designed to squelch this form of trouble, since the amplitude and frequency are known.

A few years ago, the writer aided in the solving of a problem pertaining to variable pitch propellers, as used on a number of aircraft. In this system the change of pitch of the propeller blades was obtained through a motor driving a set of gears, both located in the head of the engine. The problem arose in respect to poor functioning of the device after operating for a short period; it also created interference in the radio system. No end of troubleshooting at the time provided any solution. By suggesting an oscilloscope for observing the performance of the brushes during operation, the difficulties were readily seen and changes could be made in such a manner as to eliminate the poor operational performances. This particular application of the oscilloscope saved many hours of tedious work. Other incidental measurements were

also made, namely the strain to the gears and shafts of the engine, using simulated tests.

In the manufacture of electronic timers (this includes all types), the oscilloscope again leads for accurate measurements, especially in cases where the wave form is used for acting upon a device. In conjunction with a standard frequency source and electronic switch (a device permitting observation of two separate phenomena simultaneously) the impulses received or transmitted by a timer can be so applied, that their exact function can be observed.

Fig. 3 shows connections used for observing certain time intervals as used in operating relays. The behavior of circuit breakers is of importance. The duration of flashovers on opening or closing time, back E.M.F., radio-frequency components, arc structure become an easy problem by the use of the oscilloscope. Fig 4 shows a conventional way of observing the action of make or break.

Fig. 5 shows means of timing the action.

The second part of Mr. Muller's article, to be published next month, will deal with use of the oscilloscope in transformer manufacture, in mechanical synchronization applications and in the field of Physics and Metallurgy.

## WHAT'S YOUR IDEA OF THE IDEAL POST-WAR RADIO & TELEVISION SERVICE BENCH

Every Month!  
**\$100 in WAR BONDS**  
Given For **BEST LETTERS!**

★ Each Month's 1st Prize,  
a \$50 Bond. 2nd and 3rd  
Prizes each a \$25 Bond.

Contest Now in Progress.  
Ends December 31, 1944.

★ **THINK OF IT—**

You can win a War Bond just by putting down your ideas as to what the ideal post-war Radio Service Bench should be. How many and what type of testing instruments for use on Radio, F-M, Television and so forth. How it must be arranged to render most efficient service—confidence. Your Ideal Service Bench.

★ **ANYONE CAN WIN—**

You can win. We want opinions from everyone interested in Radio and Television Service—Old Timers—Beginners. Experience will help—new-comers with good ideas can win.

★ **ENTER EACH MONTH—**

If you don't win this month, write again next month—and next—until the contest closes. Remember, it is your opinion that wins, not literary ability. It's Easy to Enter and the Rules Are Simple! Get That Letter Off to Us Today!

### RULES OF THE CONTEST

1. Simply write a letter (500 words or less) on the subject: "My Idea of the Ideal Post-War Radio and Television Service Bench."
2. Contest is open to all readers of Radio-Craft (excepting employees of Burlingame Associates, their relatives, or their Advertising Agency).
3. You need not own a Radio Shop or possess any of the equipment you describe.
4. No detailed technical description of the apparatus is required or desired, nor the names of the manufacturers.
5. Mention of elaborate testing equipment suitable only for exhibition use will detract from the value of the letter. The inclusion of useful, confidence-creating apparatus, however, is recommended.
6. Literary ability is not required. Anyone writing in understandable English, giving a good word description, has an equal opportunity of winning one of the prizes.
7. Write only on one side; sign your name and address CLEARLY in the upper-right-hand corner; number each sheet.
8. Contest runs 6 months, July 1, 1944, through December 31st, 1944. Each month's contest begins first of that month with deadline for entries the last day of that month. Enter as often as you like.
9. No letters will be returned. Letters, contents and the ideas contained therein become the property of Burlingame Associates.
10. Judges' decisions will be final and duplicate prizes awarded in case of ties.

SEND ALL ENTRIES TO  
**BURLINGAME ASSOCIATES**

10 MURRAY STREET—NEW YORK 7, N. Y.

**FADA'S S.M. 81 SERVICE MANUAL**

**AN INDISPENSABLE AID TO THE SERVICE MAN**

Here's the Book You've Been Waiting for!

Contains all available Service Data on all FADA Receivers \$1.00 Plus Postage

Send for it Now!

**FADA OF NEW YORK**  
928 BROADWAY NEW YORK, N. Y.  
Large Stock of Replacement Parts & Cabinets

**Radio AND ELECTRONIC DEVICES**

**BURSTEIN-APPLEBEE CO.**  
1012-1014 McGee St. • Kansas City 6, Missouri

**Complete Plans**

For Building Useful and Practical Things at Home. Each issue of Popular Homecraft is crammed with plans for making such beautiful and useful things as: Furniture, Bird Houses, Lamps, Outdoor Garden Furniture, Candle Equipment, etc. Covers lathe work, tools, wood-working, leathercraft, copper, etc. You'll find "how" to make almost everything from the pages of Popular Homecraft. Scores of drawings and photographs make every step simple as A B C. A real "How-To-Do-It" magazine.

**Six Months' Trial \$1.00**

Send \$1.00 today for trial six months' subscription Money Back If Not Delighted.

**POPULAR HOMECRAFT**  
697 Palmolive Building Chicago, Ill.

**Trial 6 Months \$1.00**

**Inventions Wanted**  
Patented or Unpatented

We have been successfully selling inventions, patented and unpatented, since 1924. Write us, if you have a practical, useful idea for sale.

**CHARTERED INSTITUTE of AMERICAN INVENTORS**  
Dept. 111, 631 Pa. Ave., N.W., Washington, D. C.

**TRAIN FOR RADIO-ELECTRONICS IN 12 WEEKS**  
I WILL FINANCE YOUR TRAINING

Prepare for a good job now with a peace time future in Radio-Electronics by 12 weeks of practical shop work in the great Coyne Shops. "Learn by Doing." Whether or not you have had Radio-Electronics experience you need Coyne training. Free Employment Service for life. Many earn while learning. Mail coupon today for free book which tells you how hundreds have become successful after taking our training. We have facilities for physically disabled men. Ask for details.

H.C. Lewis, Pres., Radio-Electronics Div., Coyne Electrical School, 500 S. Paulina St., Dept. 74-8H, Chicago 12, Ill.  
Send Free Radio Book and all the facts.

NAME \_\_\_\_\_  
ADDRESS \_\_\_\_\_  
CITY \_\_\_\_\_ ZONE \_\_\_\_\_ STATE \_\_\_\_\_

# Progress in Invention

Conducted by I. QUEEN

## ECHO SOUNDING DEVICE

Patent No. 2,350,080

This is a device to indicate the direction and magnitude of a wave disturbance, to be used in connection with echo soundings on board ship, for instance. It is an invention by Donald Orr Sproule, London.

As shown, four cross-bars (F) are mounted on an assembly containing a sphere (I) at the top, the pivot being a sphere in a conical recess (Fig. 1). The extremity of each cross-bar is connected to a diaphragm (d) supported peripherally at (e). When a sound wave strikes the large sphere (I) the entire assembly vibrates, causing movement of the corresponding diaphragms in the fields of pot magnets. A light weight coil which is part of the diaphragm assembly (in the gap between magnetic poles) generates an EMF, diagonally opposite coils being in series (Fig. 2) and led to amplifiers (m) and (m') and thence to

oscilloscope deflecting plates. The screen of the scope is scaled so that the direction and intensity of the disturbance may be measured.

Displacement of the electron beam is thus the result of the vibration of sphere (I), direction and magnitude depending upon the impinging sound wave. By noting the direction (θ) and length (R) of the line on the scope screen, the incoming wave is completely determined.

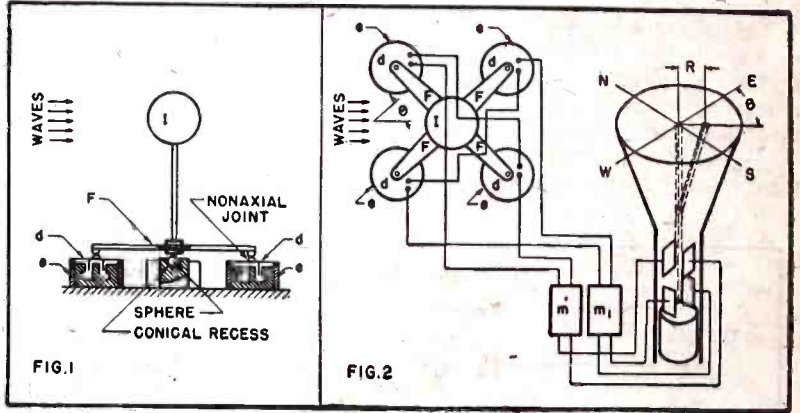

## ELECTRONIC FURNACE CONTROL

Patent No. 2,349,437

It is often required to work with exceedingly small voltages which must be controlled or recorded. Direct electronic amplification is not possible because of the small magnitudes involved. The present device eliminates previous difficulties and results in a stable, rugged and instantaneous acting instrument. As shown, it is used to control the temperature of a furnace, 1.

A thermocouple, 2, has its output connected to flexible contacts, 3, 4, on a revolving disc, 5. The contacts successively charge the various condensers on the disc. After the final condenser, 6, has been charged, contacts 7, 8, touch terminals, 9, 10, the sum of all the voltages on the individual condensers appears across them, since all condensers are in series. This sum voltage charges condenser 11.

The difference between the latter voltage and that across the left side of the slide-wire, 12 (due

to the battery) appears across resistor 13 and is amplified by tubes 14, 15. This is followed by two more stages, 16, 17 and 18, 19, the output of which is fed to the reversible motor windings, 20, 21, the direction of rotation depending upon whether the voltage across 11 being larger or smaller than that across the left-hand portion of the slide-wire.

This motor actuates the screw threaded shaft, 22, causing movement of the contact, 23, until the two voltages are balanced. Movement of 23 not only records on the chart, 24, but also closes contact to either 25 or 26 to rotate another reversible motor, 27, at the furnace. The latter adjusts a fuel valve maintaining automatic furnace temperature.

This invention is due to Earl A. Keller of Norristown, Pa., and is assigned to the Brown Instrument Co. of Philadelphia.

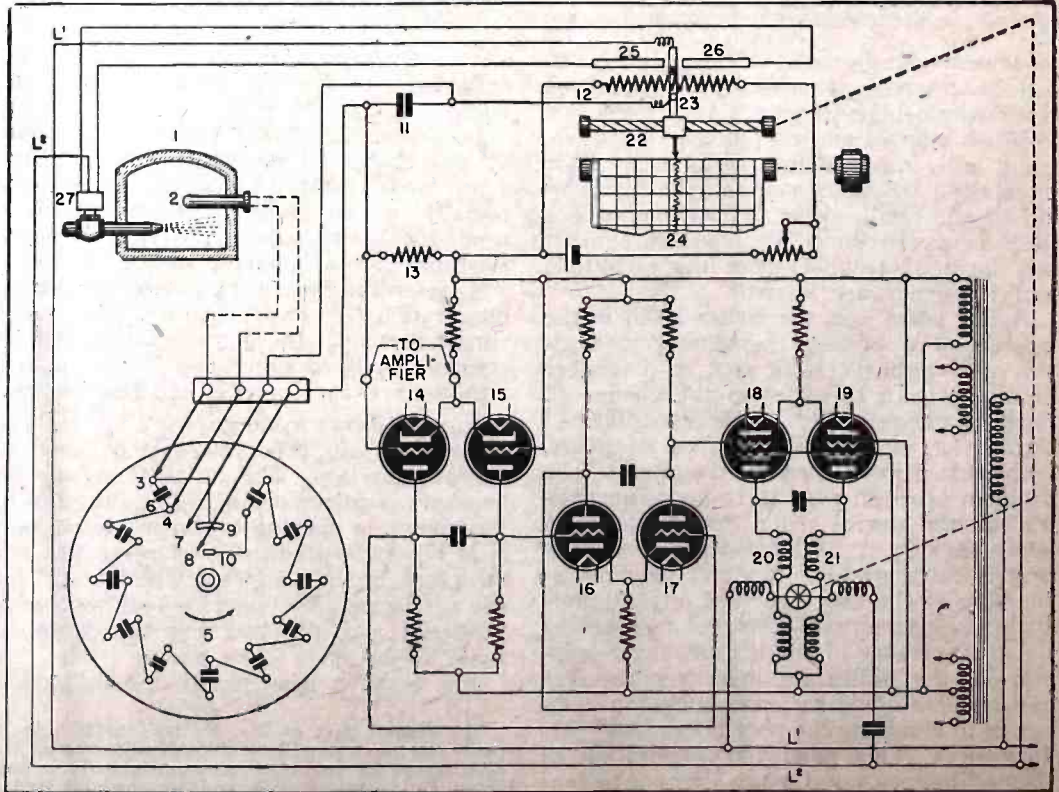

## RADIO OPPORTUNITIES

(Continued from page 11)

radio personnel will be required in this new branch of radio, be it transmission, reception or other sub-divisions of FM radio.

Thousands of new technical positions will be open to fill this great demand of manpower, and it is a safe bet that a very large percentage will come directly from the ranks of ex-servicemen.

But whether it is FM, television, broadcasting, reception, radio manufacture, or what-not—all these radio branches are intimately related. Therefore those men who have an excellent groundwork in radio and those who understand radio principles from their fundamentals up, will have little difficulty in fitting themselves into the various branches.

Therefore radio knowledge is paramount and must come before anything else. While radio theory and book knowledge is necessary, actual and practical knowledge, combined with theoretical knowledge, is what lifts the radio engineer and technician from the mediocre into the expert class. It follows that those men who really know radio theory from the ground up in its many phases, and with a practical knowledge of at least one branch of radio, will be the men who will have easy going and will fill the important positions in the post-war radio world.

Unfortunately, too many young men are not thoroughly posted in radio and they do not know their one selected subject too well. It is these men who will find it difficult to obtain good positions or connections after the war is over. Others who want to rest on their laurels think that if they have learned the rudimentary principles of radio they will get by. The trouble here is that they always forget that radio of even five years ago is an obsolete art today. There is so much new in radio from day to day, from week to week, that it is often difficult even for the experts to keep up in their own branches. *The one art in which you cannot stand still for even one month is radio, because of the lightning-like changes which occur continuously.* The able radio engineer and technician MUST keep up with the procession and further, he must continuously digest a large volume of the latest radio literature, if he does not wish to be outdistanced by others.

Referring to some of the specific questions of our correspondent, he makes mention of the radio servicing field. This also will expand by leaps and bounds in the post-war future. Much that has gone before in radio already is obsolete. New methods, new instrumentalities in radio servicing are coming about continuously in a never-ending stream. The radio serviceman worth his salt also must be an expert in his line, otherwise he will not be able to make a living. Extensive book knowledge, current radio literature and long practice, is absolutely essential. Furthermore, the more elaborate the technical equipment at the disposal of the radio serviceman, the faster he can work and the greater his profits. There will be much new radio servicing equipment after the war and many changes will no doubt be made. Yet certain up-to-date instruments can be had today which will serve as a beginning, as long as not too much money is invested in present-day equipment.

While the Government will sell some test equipment, it will probably be a long time before such equipment will find its way into the market. None will be sold directly to individuals by the Government in single lots; most of it will be disposed of through commercial channels. Much of

it also will be sold abroad to other countries by the Government War Surplus Administration. It would be best not to bank on buying such servicing instruments until sometime after the war.

There is no radio future for the man of limited training and experience—he must become an expert or near-expert in his line; and if he is studious and ambitious, as our correspondent, there should be no difficulty in rising to the top.

### NOTICE TO READERS

RADIO-CRAFT is constantly in the market for good suggestions for radio cartoons which you will have noticed in the magazine. Please see page 64 for further information.

## 100 TRANSMITTERS SOLD

ANNOUNCEMENT of the release of 100 250-watt transmitters by the War Production Board last month brought a deluge of orders from broadcast station owners desiring to replace old equipment. The manufacturers, Transmitter Equipment Mfg. Co. (Temco) of New York, reported that immediately after the publication of the report that they were available, the switchboard was clogged with inquiries.

The transmitters were originally ordered for the Signal Corps, but became available for civilian purchase due to cancellation of the contract. Originally intended to be used as straight communications transmitters with an output of 2,000 watts, they are said to be readily convertible to use as 250-watt broadcasters, and were being purchased with that end in view.

Photo Courtesy Pan American Airways

### FOR MOBILE RADIO TRANSMITTERS AND SOUND EQUIPMENT

- Resistant to high humidity, wide temperature ranges, mechanical shock and vibration
- Frequency curve scientifically designed for highest articulation through interference and background noise
- The new Electro-Voice Model 600-D is available in high or low impedance output
- Lightweight, can be held for long periods without fatigue
- Shock-proof, high impact molded phenolic case
- Press-to-talk switch (switch-lock optional) for relay operation, with choice of switching circuits

To the growing list of Electro-Voice developments, we now add the Model 600-D which may be adapted to a number of essential civilian applications. Built to rigid wartime specifications, it reflects the painstaking care of the Electro-Voice design laboratory. Electro-Voice Microphones serve you better . . . for longer periods of time.

If your present limited quantity needs can be filled by any of our Standard Model Microphones, with or without minor modifications, please contact your nearest radio parts distributor.

PAPER PACKS A WAR PUNCH . . .  
 . . . . . SAVE EVERY SCRAP

ELECTRO-VOICE MANUFACTURING CO., INC. • 1239 SOUTH BEND AVENUE • SOUTH BEND 24, INDIANA  
 Export Division: 13 East 40th Street, New York 16, N. Y. — U. S. A. Cables: ARLAB



# UNIMETER

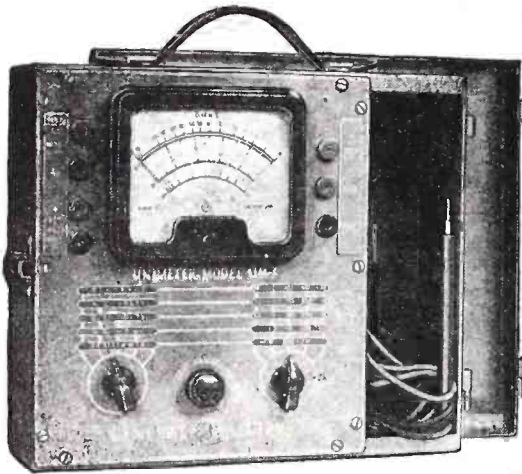

• Completely portable all-around utility instrument, ideally suited for reliable service work. Large meter calibrated to reduce the error possibility in readings makes the G-E unimeter a popular one with servicemen.

Other General Electric units available for testing electronic circuits and component parts are: audio oscillators, oscilloscopes, condenser resistance bridges, signal generators and other utility test instruments.

For complete details about the new General Electric line of SERVICE TESTING EQUIPMENT, please fill out the coupon below. . . .

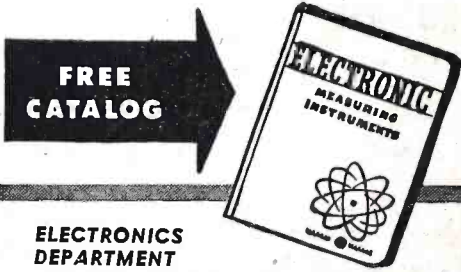

**ELECTRONICS DEPARTMENT  
GENERAL ELECTRIC CO.  
Schenectady, N. Y.**

Please send, without obligation to me, the General Electric Testing Instrument Catalog, R-10 (loose-leaf), for my information and files.

Name \_\_\_\_\_  
Company \_\_\_\_\_  
Address \_\_\_\_\_

**GENERAL ELECTRIC**  
Electronic Measuring Instruments 164-C10

## 3 TUBE VOLT METER (Continued from page 24)

reads zero regardless of the position of the reversing switch.

To calibrate the low voltage ranges I used "B" and "C" batteries that I had on hand. Turn the volts range switch to the 0-5 volts and using a 4½-volt battery as a source of D.C. adjust the 25,000-ohm potentiometer until the meter reads exactly 4½ volts. If the zero adjustment has been made correctly this potentiometer need not be touched when calibrating the other voltage ranges.

The volts range switch is placed on the 0-25 volt position and calibrated with a 22½-volt battery or any other source of D.C. voltage. If the meter does not indicate the correct voltage the 8-megohm resistor is incorrect and should be replaced with one of correct value, or a combination of resistors may be used to equal 8 megs. The remaining ranges are adjusted in the same way.

It is best to use a D.C. voltmeter and leave it across the source of voltage when adjusting the various voltage ranges. If the 0-5 volts range is adjusted carefully and the resistors used for the other ranges are of the correct value the meter will read correctly for all ranges and need not be further calibrated unless the operator notices inaccuracies.

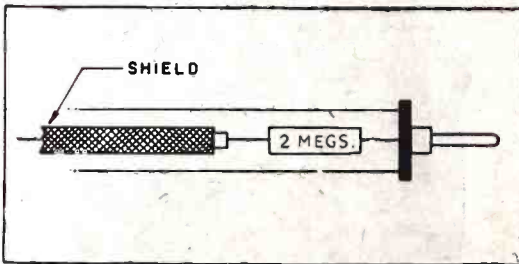

Fig. 2—Construction detail of the test probe.

The ohmmeter section is calibrated by measuring a number of resistors of known resistance and plotting a chart for each range of the instrument as shown in Fig. 4. The meter dial scale used had three ranges printed on it, 0-50-250-1000 volts, and may be purchased from any large radio supply firm to replace the scale furnished with the meter.

To measure A.V.C. voltage place the probe on the A.V.C. bus, the grid of any tube receiving A.V.C. voltage or the source from which it originates, usually the diode plates of the second detector. If the voltage developed by a strong signal is low, look for leaky condensers, weak tubes or misalignment.

Frequently a converter tube will check "good" in an emission test but shows poor results when placed in the set. This condition may be due to the tube ceasing to function at certain frequencies and can be checked by placing the probe on the oscil-

**R**ADIO equipment in each new B-29 Superfortress amounts to one ton. Colonel Hobart R. Yeager, commanding officer of the Signal Corps Aircraft Signal Agency, reported last month.

The installation nearly doubles that in the Flying Fortress, and is far ahead of other American aircraft, whose radio sets range in weight from one-half to 550 pounds.

The B-29 carries radio equipment to provide for all eventualities in the way of communications or navigational requirements. Conversations between aircraft in

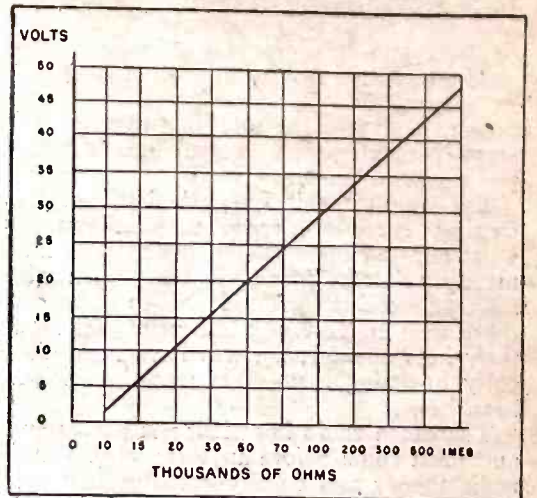

Fig. 3—Specimen chart of the ohmmeter scale.

lator grid and rotating the condenser gang. If the tube stops oscillating or the voltage generated is too low at certain positions try a new tube and check the various components of the oscillator circuit for leaky condensers, shorted turns in the oscillator coil or changed resistance values.

Leakage in coupling condensers can be easily measured by removing the tube following the condenser and checking the voltage at the grid terminal of the socket. If a positive voltage is indicated the condenser is leaky and should be replaced.

Actual tube voltages in resistance coupled circuits may be readily measured as well as voltages in any part of the receiver. When taking voltage readings under actual operating conditions the ground lead should be connected to the cathode of the tube under test.

The operator will discover many more uses for this instrument than outlined above, and once he gets accustomed to using it will find many of his "service problems" disappearing.

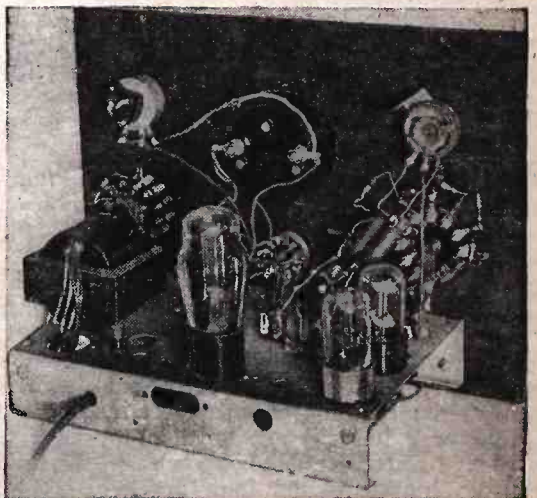

A view of the apparatus taken from the rear.

flight, between the bombers and their far-distant bases, and between crew members within a plane are all provided for. Navigational devices used allow the pilot to fly a direct or diverse route as desired, to locate bases on return with the precision of a homing pigeon and to execute safe landings. Devices to guide rescuers in the event of a forced landing at sea are also included. Radio thus acts not only to increase the fighting efficiency of the plane, but also to promote crew safety in forced landings.



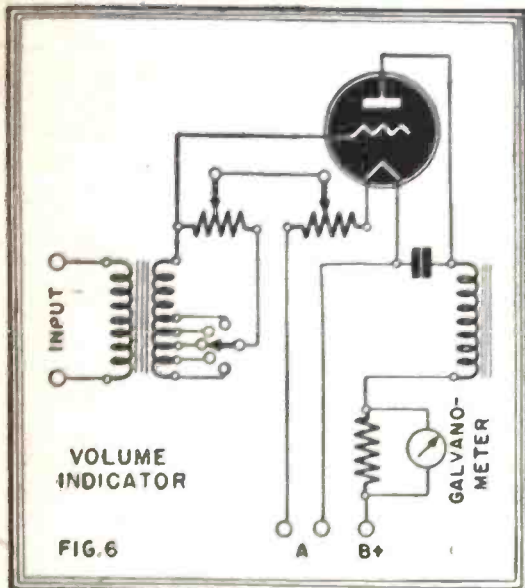

Fig. 6—Circuit of a visual volume control, employed by the engineer "riding gain."

**MASTER VOLUME CONTROL**

The master volume control, although not an absolute necessity, provides a definite advantage, in that the control-room engineer is enabled to maintain the over-all output of the mixing panel at the desired level, so that it is above the inherent noise level of the equipment, and is below that point which would exceed the amplification and modulation capabilities of the equipment which follows. This practice is known as "riding gain."

The master gain control is usually of the H- or ladder-type, and is interposed between the mixing system and the program amplifier.

**VOLUME INDICATOR**

The volume indicator is employed in conjunction with the master volume control. It indicates the volume level of the program at the output of the program amplifier, by means of a sensitive galvanometer in the plate circuit of a vacuum tube. The grid of the tube is energized by a portion of the output of the speech amplifier, and a potentiometer permits adjustment of the grid bias.

The total variation in volume of the original program may be as much as 60 db, whereas the useful volume range of the usual amplitude-modulated transmitter is about 40 db. Therefore, some "volume compression" is necessary. When riding gain, the control-room engineer must compensate for this difference by inserting loss during passages of excessively high volume, and removing it during the low passages. It is his responsibility to observe the indications of the volume level meter and adjust the master volume control accordingly.

A typical volume indicator is shown in Fig. 6. This instrument is said to be of the slow-moving type, as it indicates the average level of the peaks. The usual meter has its main scale calibrated to read in percentage utilization of the channel, while auxiliary scales may read in decibels or volume units.

**MONITOR AMPLIFIER-SPEAKER**

The monitor amplifier is usually identical or very similar to the studio program amplifier, except that it drives the monitor speaker instead of feeding the program line.

It is usually connected across the line, between the master volume control and the studio amplifier. This permits monitoring the program exactly as it enters the program amplifier, although switching arrangements are usually provided whereby other program material, such as rehearsals and auditions, may be heard and tested for quality and balance prior to an actual broadcast.

(To be continued)

Radios in Brazil number 2,590,000, says a recent report. These are served by 76 broadcast stations.

**CRITICAL PERIOD EXPECTED**

CRITICAL times—more critical than any previously faced by the radio and electronic industry—are expected in the next few months, Ray C. Ellis, director of WPB's Radio and Radar Division, declared last month.

Contract cancellations, reconversion from war work and labor problems are the main difficulties which will make the coming period one which will call for the closest co-operation between the industry and the WPB, he stated.

Members of the Industrial Instrument Industry Advisory Committee, to whom his warning was addressed, agreed that reconversion plans must not be permitted to interfere with or retard production of war-essential requirements and that all reconversion plans should be predicated on this basis.

**HE HAS YOUR BATTERY**

Today flasher signal lights and invasion-barge searchlights are more important than battery-powered lights at home. Burgess Batteries go *first* to the men who need them most, so we'll all have to take better care of what batteries we may have. Keep them cool and dry... use them as little as possible and rest them as *often* as possible.

Paper Packs a War Punch—Save It!

**BURGESS BATTERIES**

IN THE NATION'S SERVICE

Free Battery Hints—Write Burgess Battery Co., Dept. C-2 Freeport, Ill.

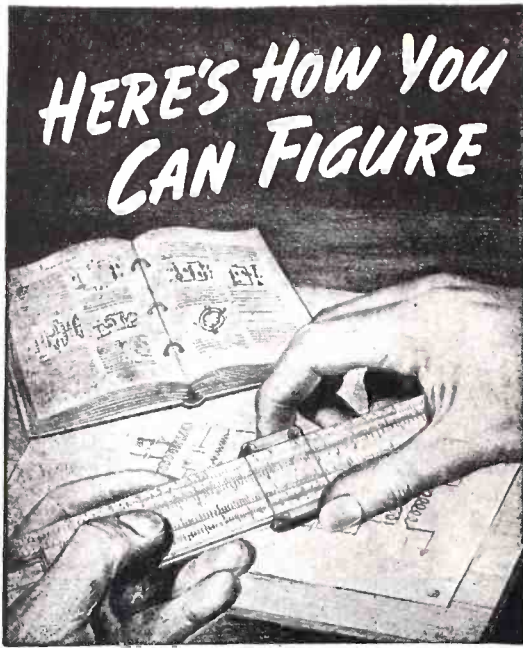

## —On a Better Job and a Secure Career in **RADIO-ELECTRONICS**

Add technical training to your practical experience . . . then get that *better job* you want!

CREI home study training in Practical Radio-Electronics Engineering equips you with the ability to go after—and get—a better, secure, engineering job.

After the war, will come the period of the "survival of the fittest." Employers can then once again afford to be "choosy" in selecting the best-trained men for the best jobs. In our proven course of training, you learn not only *how* . . . but *why!* Your ability to solve tough problems on paper, and then follow up with the necessary mechanical operation is a true indication that you have the *confidence* born of *knowledge* . . . confidence in your ability to get and *hold* an important job with a secure, promising future. . . . These jobs are waiting today for radiomen with up-to-date technical training. Investigate CREI home study training now . . . and prepare for security and happiness in the coming New World of Electronics!

### • WRITE FOR NEW, FREE 36-PAGE BOOKLET

If you have had professional or amateur radio experience and want to make more money—let us prove to you we have something you need to qualify for a better radio job. To help us intelligently answer your inquiry — PLEASE STATE BRIEFLY YOUR BACKGROUND OF EXPERIENCE, EDUCATION AND PRESENT POSITION.



## **CAPITOL RADIO ENGINEERING INSTITUTE**

Home Study Courses in Practical Radio-Electronics  
Engineering for Professional Self-Improvement  
Dept. RC-10, 3224 — 16th Street, N. W.  
WASHINGTON 10, D. C.

Contractors to U.S. Navy—U.S. Coast Guard—  
Canadian Broadcasting Corp. Producers of Well-  
trained Technical Radiomen for Industry

## SPEECH AMPLIFIER DESIGN (Continued from page 19)

producing the plate current change. For example: If a change of 1 volt on the control grid of a tube causes a change of 2 Ma. in the plate current.

$$G_m = \frac{2 \text{ Ma.} \times .001}{1 \text{ volt}} = \frac{.002}{1} = .002 \text{ mho}$$

and .002 mho is equal to 2,000 micromhos. The micromho is the value which most tube manufacturers use to designate the tube transconductance.

Transconductance may also be expressed as:

$$G_m = \frac{\text{amplification factor}}{\text{plate resistance}} = \frac{\mu}{R_p}$$

Since  $G_m = \mu/R_p$ ;  $\mu = G_m \times R_p$

From the above statement, we may see that the highest amplification will be obtained from pentodes having high values of plate resistance and transconductance.

### EQUIVALENT PENTODE CIRCUIT

The equivalent circuit which is most suitable for the pentode amplifier is the "constant current generator" type of circuit shown in Fig. 4. In this circuit we consider the input voltage,  $E_s$ , as having the same effect upon the plate current changes as a generator within the tube supplying a current equal to  $E_s G_m$ . This current is said to flow from the plate toward the cathode through the plate resistance which is paralleled by the load impedance.

Since it is necessary to employ a load impedance in such a circuit, the amplification is not quite equal to  $G_m R_p$  but is found from the formula below.

$$\text{Gain} = \frac{1}{\frac{1}{R_p} + \frac{1}{Z_L}} \times G_m$$

From the foregoing study, we see that it is imperative that the correct type of plate loading impedance be selected for proper operation of the tube as an amplifier. This load may exist in the form of an inductance or as a non-inductive resistor. The characteristics of the different types of interstage coupling are beyond the scope of this article and will be covered in a later article.

However, a few words will be said on each of the most common types.

### AUDIO COUPLING METHODS

When transformer coupling is employed, it is possible to supply a load which will match the plate of the tube for greatest efficiency. It should be noted that there is little direct current voltage loss in the primary of a transformer when compared with the losses in voltage experienced with resistance-capacitance coupling.

Transformer coupling has one distinct disadvantage when used in the amplifier unless care is used in selecting the point where it is to be used in the circuit. Careful placement with respect to other parts on the chassis is necessary because the average interstage transformer is very susceptible to hum picked up from the magnetic fields surrounding such magnetically operated devices as electrodynamic speakers, power transformers, and filter chokes. For this reason, the transformer is normally employed at such points in the circuit where the signal is at a fairly high level and excessive gain is not desired or necessary. This will keep the hum level at the lowest possible point.

Such a transformer should be placed on the chassis as far as possible away from the power transformer and filter chokes. This transformer should be so placed that the planes of its coil windings are at right angles to the planes of the windings of the chokes and any other transformers. Since it is not always possible to eliminate the hum picked up by the transformer, its use is often forbidden in the A.C.-operated amplifier.

Still other disadvantages in transformer coupling are the weight and size of high quality transformers, not to mention their unavailability during the present crisis, and perhaps for some time to come. A cheap transformer may easily become a victim of core saturation and may also have resonant points in its windings which may cause oscillation or uneven frequency response.

The main purpose of transformer coupling between two stages is that due to transformer design features, the maximum gain available from the stage may be made to

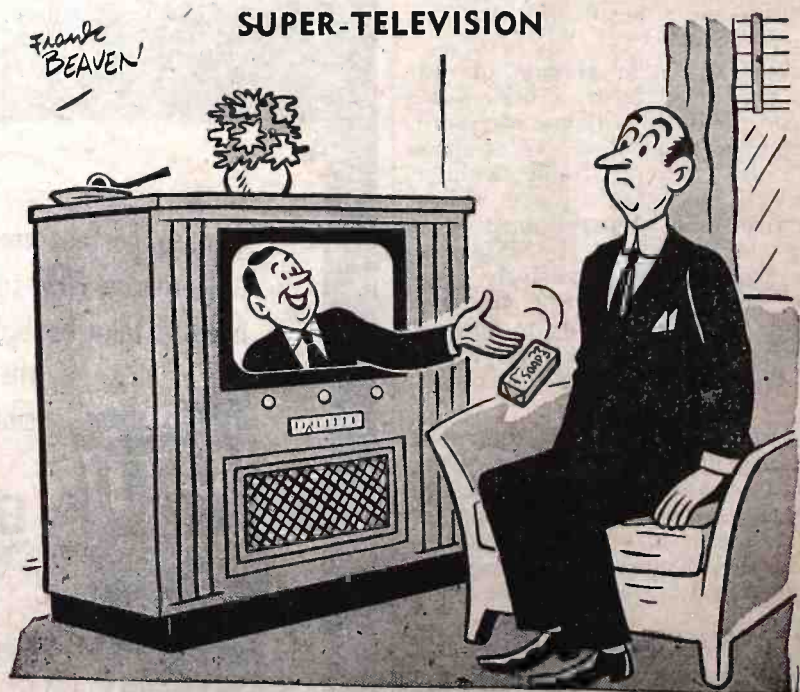

Suggested by Pvt. H. Goldberg, Scott Field, Ill.

"Here's your sample of RADIO SOAP."

RADIO-CRAFT for OCTOBER, 1944

exceed the  $\mu$  of the tube. This increase in the gain of the stage is due to the fact that it is possible to wind a transformer in such a manner that there is a step-up in the voltage between the primary and secondary. The over-all gain for such a stage is equal to

$$\text{Gain} = \mu = \frac{Z_1}{Z_1 + R_p} \times N$$

where  $\mu$  = amplification factor of the tube  
 $Z_1$  = impedance of transformer primary winding  
 $R_p$  = plate resistance  
 $N$  = turns ratio of transformer

With the high gain tubes now available, the writer can see no particular advantage in the use of transformer coupling between stages unless for some particular application.

#### RESISTANCE COUPLING

Resistance-capacitance coupling has a decided advantage in several respects. The cost of high quality resistors and condensers does not approach the cost of high quality transformers, and use only a small portion to the space required for the mounting of the transformer. The frequency response characteristic of this type of coupling does not develop unwanted peaks in some portion of the response curve, due to resonating of some of the components at certain frequencies.

In designing an amplifier, the first problem to be attacked is that of finding the total gain required. The total gain of an amplifier is equal to the required output voltage divided by the input voltage to the first amplifier stage. This figure will give the minimum voltage gain required. It is recommended that this minimum figure be multiplied by 3 or 4 in order that the amplifier will have sufficient gain for all purposes.

The required gain can usually be obtained from two or more stages if care is used in selecting the tubes and proper components. The total gain of the amplifier is equal to the product of the gain of the individual stages. That is; if a stage having a gain of 100 is followed by one having a gain of 24, the total gain is equal to  $100 \times 24 = 2,400$ .

Your writer hopes that this article serves to give you an insight into the operation of the vacuum tube as a speech amplifier. You are requested to keep your eyes open for the following article which will discuss the theory behind resistance-capacitance and transformer coupling with emphasis on frequency response characteristics of these types of coupling.

**H**EARING AID batteries are not among the products which will become more available in the near future, says a release issued last month by the War Production Board.

Officials pointed out that dry-cell batteries are used in radio communication and mine detection apparatus, as well as in many specialized types of military equipment employed in ground, sea and air operation. Military requirements for dry-cell batteries currently exceed production by about 30%.

To meet the emergency, WPB has made available to the Armed Services the entire output of two manufacturers who formerly produced hearing aid batteries in addition to batteries for the military. Other concerns are manufacturing hearing aid cells for the first time, which will partly offset the loss, but it is expected that there will nevertheless be a shortage in the next few months, and owners of hearing aids are cautioned to conserve their batteries.

## HARRISON HAS IT!

**FOR URGENT  
WAR WORK—**

**HALLICRAFTERS**

**RECEIVERS AND  
TRANSMITTERS**

**TUBES  
CONDENSERS  
RESISTORS  
TRANSFORMERS**

**AND THOUSANDS OF OTHER  
CRITICAL ELECTRONIC PARTS!**

**PURCHASING AGENTS—**

Call upon us for your high priority requirements of equipment and components for your production and development work.

**We usually have it in stock!**

**FOR THE  
HOME FRONT—**

**CODE PRACTICE SET**

Buzzer and key, heavily nickel plated, of single unit construction, mounted on wood base. Adjustable high frequency pitch. Complete with silk covered cord, in attractive box with code chart on cover. Works on one or two flashlight or dry cells.

**Postpaid—\$2.45**

**6L6G** First grade, \$1.37 ea.  
meter tested, 3 for \$3.75  
**TUBES** fully guaranteed postpaid

**DYKANOL CAPACITORS**

Cornell-Dubilier oil filled, hermetically sealed metal cased condensers. 4 mfd. capacity. Rated at 220 Volts AC working, will stand over 600 Volts D.C. Ideal for amplifiers, receivers, power packs, etc. (Filtering action equivalent to 12 mfd. electrolytic but with better safety factor, longer life). \$2.25 (3 or more shipped postpaid).

**P. M. DYNAMIC SPEAKERS**

5 inch, with output transformer to match single plate of 8000 ohms **\$1.95**

(Not Postpaid)

Immediate delivery of the above items, without priority, while quantities last. Place L-265 or V-3 certification on your order. **SEND REMITTANCE WITH ORDER, TODAY!** (Money back if not satisfied.)

**HARRISON**

**RADIO CORPORATION**

11 WEST BROADWAY

Phone WOrth 2-6276

NEW YORK CITY 7

**HALLICRAFTERS ★ HALLICRAFTERS**

## RECEIVER HEADQUARTERS

*for the Nation*

**B**EFORE the war Bob Henry served the amateurs as the world's largest distributor of communications receivers.

Now Henry Radio is Hallicrafters receiver headquarters for the Nation at war. Hallicrafters Receivers can be supplied on AA-1 priority. I can usually supply SX-28s at \$223.00, SX-25s at \$94.50, and PM-23 speakers at \$15.00 at once. It takes longer to supply other models.

Soon, it is hoped, non-priority orders can be filled and Bob Henry can become again Hallicrafters headquarters for the nation at peace.

I have stores at Butler, Missouri, and at 2335 Westwood Blvd., Los Angeles 25, Calif.

*Your orders and inquiries are invited.*

**Bob Henry, W9ARA**  
**HENRY RADIO SHOPS**

Butler, Mo. and Los Angeles, 25, Calif.

**"WORLD'S LARGEST DISTRIBUTOR OF COMMUNICATIONS RECEIVERS"**



### COMPLETE STOCKS

I have in stock some Hallicrafters receivers available for immediate delivery on priority and the following parts without priority: meter rectifiers \$1.95, transmitting tubes, transformers, resistors, condensers, panels, headsets, etc. Your orders and inquiries invited.

**HALLICRAFTERS ★ HALLICRAFTERS**



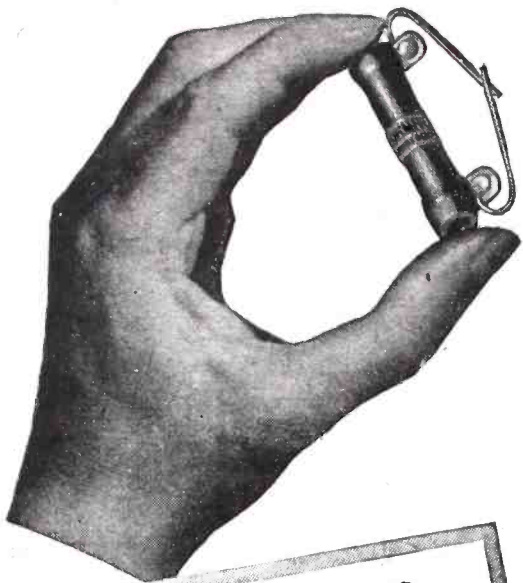

**In Resistors...**

**OHMITE**  
EXPERIENCE  
MAKES A  
DIFFERENCE

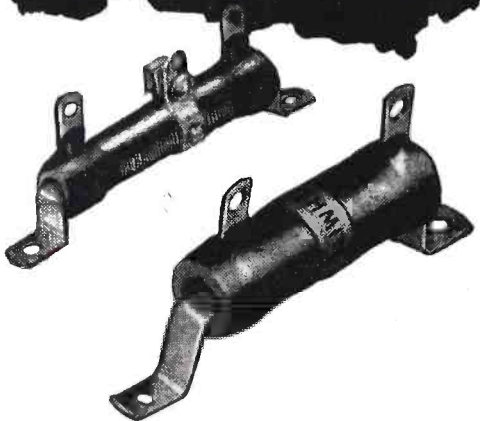

You get the benefit of Ohmite experience in meeting many different requirements . . . in pioneering new developments . . . in producing a wide range of types and sizes to best meet each need. Add to this, the long service-record of Ohmite Resistors . . . their proved ability to function under the most severe operating conditions. Such experience is invaluable in helping you solve your resistance-control problems.

**Send for Ohm's Law Calculator**

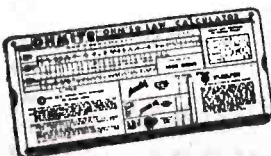

Figures ohms, watts, volts, amperes—easily. Solves any Ohm's Law problem with one setting of the slide. Send only 10¢ in coin.

**OHMITE MANUFACTURING CO.**  
4894 Flournoy Street • Chicago 44, Illinois

Be Right with **OHMITE**  
RHEOSTATS • RESISTORS • TAP SWITCHES

**INDUSTRIAL ELECTRONICS**

(Continued from page 28)

The magnetic method of geological exploration of the earth's depths is based on the principal of the magnetometer, details of which are supplied in any good physics book. It is a device for measuring the strength of magnetic fields. The magnetometers employed by the geologists are of the inductor type and when used with properly-designed electronic equipment, magnetic explorations of the variations in the earth's magnetic field may be made. The electronic amplifiers associated with the inductor coil of the instrument make the slightest changes in the magnetism of the earth's surface produce sensible effects.

Some years ago, certain geologists saw a great deal of promise in exploration through the agency of seismic effects. By this is meant production of artificial seismic conditions by the explosion of heavy charges of dynamite underneath the earth's surface. These explosions produce waves within the earth. Part of these waves will be reflected back to the surface of the earth in the manner illustrated in Fig. 2. The system now used is called the reflection seismographic method. It is already widely used by the large oil companies and much wider employment in other fields of exploration is promised. Already such equipment has made millions of dollars for oil operators.

First a shot hole is drilled in the earth near or at the spot where it is believed that a large quantity of oil exists. The charge of dynamite is placed in this hole and exploded to produce measurable seismic effects. Special microphones are placed some distance from the shot. These are fed into high-gain amplifiers, the outputs of which are in turn passed on to special recording (photographic) galvanometers. When the shot charge is exploded electrical counterparts of the earth's tremors are recorded on special film that must thereafter be processed. In a very large measure, the present system functions like the sonic depth finder employed for marine purposes and sub-sea explorations. It will be recalled that the sonic depth finder operates on the basis of data collected as the waves produced and propagated travel upward. Here the velocities of propagation and the time required to travel from the point of explosion to the reflecting interfaces and back to the recorders located at the surface of the earth determine the location and nature of strata, etc. In the case of electronic-seismic method, the shot hole is located from 50 to 100 feet below the surface of the earth.

The converted sound energy generated by the seismophones, as has been stated previously, is fed to high-gain amplifiers. These are automatically adjusted to a given level and the undesired components are filtered out before the small current is passed to the especially designed recording galvanometers.

The time interval marks are made at 0.01 second and the instant of the explosion is recorded on the record as well as the seismic waves, both reflected and refracted.

The proper use of this equipment requires that the seismophones be placed at certain intervals on the surface of the earth and in a certain pattern in relationship to the shot hole. The seismophones are usually separated by a distance of 200 feet. It is then possible to differentiate between the direct, reflected and refracted waves based on their difference in apparent veloc-

**FOR SALE**  
**HARD-TO-GET ITEMS**

All items are brand new, except where indicated. ALL are in PERFECT WORKING ORDER. In many cases, the parts alone total more than the price we are asking. Satisfaction guaranteed or your money back. ORDER FROM THIS PAGE. Use our convenient coupon. Include sufficient extra remittance for parcel post charges, otherwise order is sent express collect. Any excess will be refunded. All C.O.D. shipments require 20% deposit. No C.O.D. shipments on orders for less than \$5.00. If full remittance accompanies order deduct 2% discount. Send money order, certified check, or new U. S. stamps. No C. O. D.'s to foreign countries.

**THE MAGIC ELECTRIC WELDER**

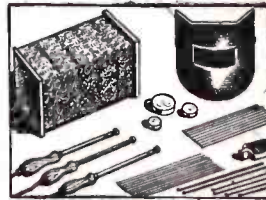

Here is one of the most compact, practical welders we have ever seen. Anyone can use it for shop, farm and home repairs. WELDS, BRAZES, SOLDERs, CUTS ALL METALS. ANYONE CAN OPERATE IT. Repairs steel, cast iron, aluminum, brass, copper, bronze, etc. Complete with power unit, flame and metallic arc attachment.

(Really two welders in one). Carbons, fluxes, rods, mask included. Just plug it in any electric outlet. 110 volts AC or DC. For hobbyist or professional. GET IN ON THE GREAT WELDING BOOM. This fine set quickly teaches you welding. Low cost to operate—about 5¢ an hour. COMPLETE SAFETY is assured. No fumes with this outfit. SET COMES COMPLETE—nothing else to buy. Used by the U. S. Navy, American Tel. & Teleg. Co.; Eastman Kodak Co.; Bell Laboratories, etc. BRAND NEW OUTFIT. Guaranteed for one year. Simple instructions with each set. ITEM NO. 158 YOUR PRICE . . . . . \$19.95

**WESTERN ELECTRIC BREAST MIKE**

This is a fine light-weight aircraft carbon microphone. It weighs only 4 lb.

Mike comes with breastplate mounting and has 2-way swiveling adjustment so that it can be adjusted to any desired position. There are 2 woven straps; one goes around neck, the other around chest. Straps can be snapped on and off quickly by an ingenious arrangement.

This excellent mike can be adapted for home broadcasting or private communication systems. By dismantling breastplate, it can be used as desk mike.

Complete with 6-foot cord and hard rubber plug. Finished in sherdardized plate, non-rustable. THIS IS A BRAND NEW MIKE. IT HAS NEVER BEEN SOLD AT SUCH A LOW PRICE BEFORE. ORIGINAL LIST PRICE \$15.00. Shipping weight, 2 lbs.



ITEM NO. 152 YOUR PRICE . . . . . \$2.55

**POWERFUL ALL-PURPOSE INDUCTION MOTOR**

IDEAL FOR EXPERIMENTERS—101 USES

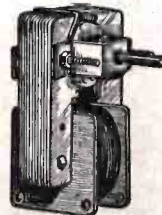

Sturdily constructed to precision standards, this self-starting shaded pole A.C. induction motor is powerful enough for a number of uses. Some of these are: Automatic Timing Devices, Current Interrupters, Electric Fans, Electric Chimes, Window Displays, Photocell Control Devices, Electric Vibrators, Small Grinders, Buffers and Polishers, Miniature Pumps, Mechanical Models, Sirens, and other applications.

Consumes about 15 watts of power and has a speed of 3,000 r.p.m. When geared down, this sturdy unit will constantly operate an 18-inch turntable loaded with 200 lbs. dead weight—THAT'S POWER!

Dimensions 3" high by 2" wide by 1 1/2" deep; has 4 convenient mounting studs; shaft is 1/8" long by 3/16" diameter, and runs in self-aligning oil-retaining bearings. Designed for 110-20 volts, 50-60 cycles, A.C. only. Shp. Wt. 1 lb. ITEM NO. 147 YOUR PRICE . . . . . \$1.95

**LIMITED QUANTITIES!**  
**PROMPT SHIPMENTS!**

It's Easy to order—Clip Coupon—Order from This Page—No Catalog Sent.

(See Corresponding Ad. Page 59)

**MAIL TODAY—NOW!**

**HUDSON SPECIALTIES CO.**

40 West Broadway, Dept. RC-10-44, New York 7, N. Y.

I have circled below the number of the items I'm ordering. My full remittance of \$ . . . . . (include shipping charges) is enclosed. (NO C.O.D. ORDERS UNLESS ACCOMPANIED WITH A DEPOSIT.)

OR my deposit of \$ . . . . . is enclosed (20% required), ship order C.O.D. for balance. NO C.O.D. ORDER FOR LESS THAN \$5.00. (New U. S. stamps, check or money order accepted.)

Circle Item No. wanted 147 152 155

Name . . . . .

Address . . . . . Please Print Clearly

City . . . . . State . . . . .

Send remittance by check, stamps or money order; register letter if you send cash or stamps.

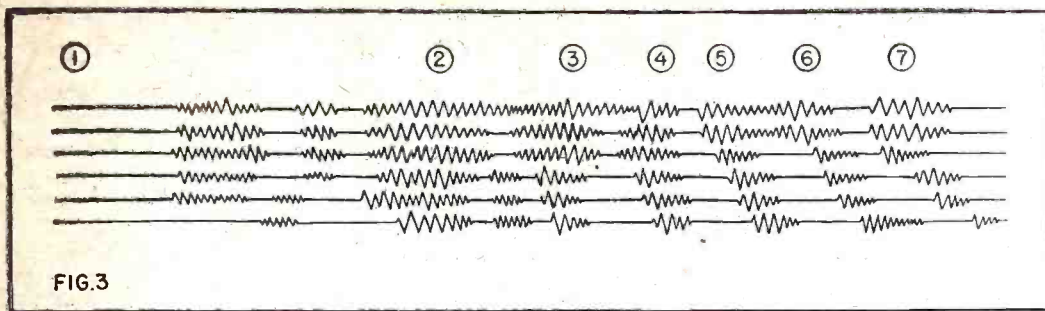

Fig 3—A graph of the sound-waves received by each of the several microphones in the set-up of Fig. 2. By noting time intervals between the waves, the subterranean strata may be mapped.

ity. The variation in arrival time at the various pick-up stations around the shot hole is usually much greater for the refracted waves than for the reflected waves. It sometimes happens that the waves reflected from the deep strata arrive at the pick-ups at precisely the same moment even though the extreme separation be as much as 1,000 feet. The interval separation in the case of the refracted wave over the same distance may amount to 0.01 second or more; in any event, a rather easily measured interval of time.

This time differential is extremely important. For one thing, the reflected waves may be very easily separated from the refracted waves. Simultaneous recordings on two sides of the shot point supply auxiliary data for the proper identification of the reflections. The lapse of time between the interval of explosion of the shot-hole charge to some definite characteristic of this event is recorded to the nearest one thousandth second. The actual depth of the reflecting strata is then computed from these periods of time.

In this manner contour maps may be prepared showing the deep strata or the shallow strata, the equipment being effective from a depth of 200 to 20,000 feet. The survey, when applied to large areas, will result in maps that often reveal petroleum deposits of great extent.

The reflection seismograph record (Fig. 3) holds six simultaneously recorded lines or channels. These come from the six seismophones separated some 200 feet apart in line in the shot hole.

The instant the dynamite explodes is indicated at 1. The refracted waves recorded on the six channels represent the first arrival at the seismophones of the impulses due to the explosion. The refracted waves, recorded on the galvanometers show the initial arrival of the disturbances due to the explosion. The point indicated at 2 shows a shallow reflection and those points indicated at 3, 4, 5 and 6 are also characteristic reflections. In the case of this particular record made by the expert, Mr. Derry H. Gardner of the Geophysical Department of the Humble Oil Co., the point marked 7 occurred 2.327 seconds after the explosion of the dynamite in the shot hole and represents, on the basis of careful calculation, a depth of approximately 10,000 feet. The recordings made beyond this point (7) are due largely to wind and nearby movement of truck traffic, the equipment used being extremely sensitive to such mild disturbances.

As is well known, the velocity of sound waves depend in a very large measure upon the nature and density of the medium through which they pass. The speed is relatively slow through air, faster through water and still faster through steel. This rule holds in the case of the earth, the speed of waves being relatively slow through the soft media and rapid through hard rock strata. This difference in velocity may amount to as much as eight to ten thousand feet per second. In the case of shallow

formations, the velocity of the waves may easily fall below the velocity of sound through air. This has been recorded as low as 800 feet per second compared with 1100 through air.

Much of the electronic and radio equipment used in this method has been specially developed for the purpose. The mikes used are of the variable reluctance or moving armature types. Such instruments have the ruggedness required of such equipment. In the case of the variable reluctance microphones, the coil is perfected to work in conjunction with a low impedance winding of the amplifier input transformer.

The frequencies of the reflected waves vary in a large measure. They may be as high as 80 cycles or as low as 20 cycles. Experience with this kind of equipment over the past few years has shown that the frequencies of the reflected waves are higher than the frequencies of the direct waves. Filter circuits are arranged to favor these frequencies and the amplifiers used recording the reflected waves are equipped with band pass filters. These increase the sensitivity of the equipment sufficiently to greatly reduce the size of the charge of dynamite that might otherwise be required.

Radio transmission is used in preference to wire telephone between the various trucks employed in this new service. Thus when the shot-hole charge of dynamite is exploded, the detonator electric circuit is opened and the electric impulse is impressed on the modulating equipment of the transmitter employed. The signal is emitted at the exact instant of explosion and is received at the recording truck and recorded on a moving coil galvanometer unit.

Once a survey measurement has been completed by the use of the equipment discussed, the marks for the subsequent drilling may be laid out with some prospect of success when the earth is punctured at the points indicated. Oil companies have thus enormously reduced the number of drilling operations that do not pay out.

Electronic equipment is also employed on oil drills to indicate the nature of the deposit through which the drill passes. All in all, electronic equipment is doing very nicely in the oil business and in geology at large.

**HITCH-HIKERS**, those annoying commercial spot announcements sandwiched in between two programs, will be entirely eliminated from NBC's sponsored programs, it was stated last month by Roy C. Witmer of NBC. This follows an earlier announcement of CBS that such announcements would be discontinued on October first.

There is no ban on advertising more than one product on an NBC program as long as the total commercial time does not exceed the code limits, Mr. Witmer explained, but all these secondary announcements are now surrounded with some sort of entertainment such as theme music which brings them within the framework of the program.

## "DEAD" TUBES BROUGHT TO LIFE!

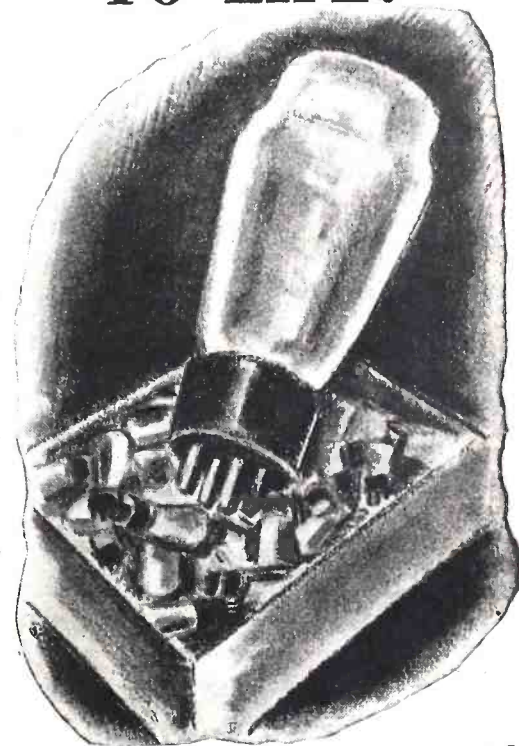

*Don't throw away your old tubes! This new, improved technique by the R T S Laboratories does the following:*

1. REACTIVATES THORIUM
2. CONNECTS OPEN FILAMENTS
3. CLEARS SHORTS & MICROPHONICS

The R T S Process restores practically any type of tube including

50L6 12SA7 12SK7  
12SQ7 35L6 35Z5, etc.

Pick out all your "Dead" tubes (Make sure glass, base and prongs are intact—"Flashed", "Exploded" or "Open Cathodes" not acceptable).

Send all your "Dead" tubes to our laboratory with your packing list . . . In a few days we will return them *fully reprocessed* with our **GUARANTEE for 30 DAYS** Efficient Performance.

Every tube fully checked not only in tube checkers but also in set for playing.

**50¢ Each . . . \$1.00 on 1 Volt tubes including 3Q5**

Packing slip must accompany each order.

*R T S Reprocessing service now in use by many firms of national prominence.*

*Approved by O.P.A.*

**R T S RADIO TUBE SERVICE CO. INC.**  
6805 20th Avenue, Brooklyn 4, N. Y.

ORGANIZE YOUR PAPER WORK

# SYLVANIA SERVICEMAN SERVICE

by  
**FRANK FAX**



SYLVANIA offers you ready-made forms, imprinted with your name, at cost, to streamline your paper work.

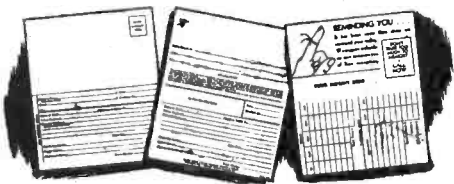

**THREE-IN-ONE SERVICE FORM.** A complete job record for your files; customer's invoice, guarantee, and imprinted follow-up cards; all in one handy form, perforated for easy use. 100 for \$1.50; 250 for \$2.50; 500 for \$5.00.

**JOB RECORDS.** Customer's record and receipt, imprinted, and a complete job record for your files. 100 for \$1.00; 250 for \$1.75; 500 for \$3.00.

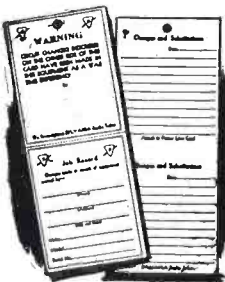

**CIRCUIT CHANGE WARNING**  
Card detailing wartime emergency circuit

changes and tube substitutions for your files, to be attached to customer's set for future reference, imprinted and perforated for easy use. 100 for \$1.00; 250 for \$1.75; 500 for \$3.00; 1000 for \$5.00.



**BUSINESS RECORD BOOK.** A simple week-by-week bookkeeping system, specially designed for your business. Used with Three-in-One Service Forms, it gives you complete business records for tax and other purposes. \$1.00.

Send your order to your Sylvania jobber or to Frank Fax, Sylvania, Emporium, Pa.

# SYLVANIA

**ELECTRIC PRODUCTS INC.**

RADIO DIVISION

## PRACTICAL ELECTRONICS (Continued from page 29)

To understand this action, a knowledge of alternating current action in reactive circuits is necessary. Should the student not have such knowledge, it might be a good idea to re-read the articles, "Condensers, Chokes and Lenz's Law," "Phase—Don't Let It Phase You," and "Resonant Coils and Reacting Condensers," in the April, May and June issues of 1943, which cover the subject.

### CHANGING THE PHASE

Fig. 1 is an ordinary transformer with its primary in the A.C. circuit which supplies the rectifier. Its secondary (wound to the required voltage) may be attached between grid and cathode of the same tube, and furnishes its firing voltage. Note that if the top of the secondary is attached to the grid the voltage will be in phase with that of the plate and the tube will fire at the beginning of its conducting cycle. If the connections are reversed (cathode at top of secondary) the grid will reach its maximum in one direction when the anode voltage is at a maximum in the other. In such a case most tubes will not fire at all.

The important thing to notice is that we have a change of 180 degrees (half a cycle) in the phase relationship of anode and grid voltage, simply by reversing connections on a transformer secondary. If we can find some means of varying the grid voltage between those two points, we have a control system.

### A GRID-CONTROL DEVICE

Such a system is found in Fig. 2. Instead of switching cathode and grid leads on the transformer, the cathode lead is attached to the center-tap. Now we can get our 180 degrees difference merely by moving the grid from one end of the winding to the other. By using a condenser (C) and a resistor (R) and varying their size, we can change the electrical distance of the grid from either end, causing the grid voltage to cross the zero voltage line of Fig. 1 at intermediate points between zero and 180. (The resistor in series with the grid is to prevent heavy currents when the tube is conducting and the grid is positive.)

For example, with a resistor of extremely high resistance and a large condenser of very low reactance, the effect is practically the same as if the grid were attached to the top of the transformer secondary. The voltage of the grid will rise and fall with that of the anode (Fig. 1-a). If the condenser is very small (high reactance) and the resistance also small, the grid is in ef-

fect attached to the lower end of the winding and the grid voltage will rise and fall 180 degrees from that of the anode (Fig. 1B).

If the condenser and resistor have an equal impedance to alternating current, the grid voltage will be 90 degrees out of phase with that of the anode, and will pass the zero line when anode voltage is at its peak.

"But," some student may object, "why all the trouble with a resistor and condenser? Why not simply put a variable resistor across the transformer secondary, connect the grid to the moving arm, and adjust the voltage point volume-control fashion?" There is only one hitch in this proposition. It would adjust phase beautifully, right from zero to 180 degrees. The voltage would vary, however, from maximum when the arm was at either end of its swing to absolute zero at the exact center.

The combination of condenser and resistor in series maintains the same voltage at the center—or 90-degree point—as at either end. To understand exactly how this happens, let us assume that the transformer delivers 20 volts each side of the center tap—in other words is able to swing the grid 20 volts either way from the cathode. We can represent this voltage by the horizontal line of Fig. 3-a.

Now assume we have a condenser and resistor of equal impedance—for ease in calculating, let us say 200 ohms each. Then the total impedance in circuit would be 400 ohms—or would it? Of course it would not! Capacity and inductance act—mathematically speaking—at right angles to resistance, and to calculate the total impedance they must be so added.

We therefore take a line 200 units long (one-tenth millimeter per unit is a convenient scale) to represent the resistance and another line of the same length for the reactance. Mathematical tradition says the resistance line should be horizontal and the capacitive reactance line drawn downward from it. Connecting the two free ends, we have the triangle of Fig. 3-b, the hypotenuse of which, approximately 283 units long, is the impedance we are seeking.

Given an impedance of 283 ohms, the current in circuit (from the 40-volt transformer) is roughly 0.142 ampere. The voltage across each section of our impedance is then 28.4 volts. Drawing these in connection with our figure of the transformer voltage, we have Fig. 3-c. The voltage across each unit is drawn from the end of

An interior view of one of the various types of timer controls, used in welding and other applications. A resistor is the variable unit.

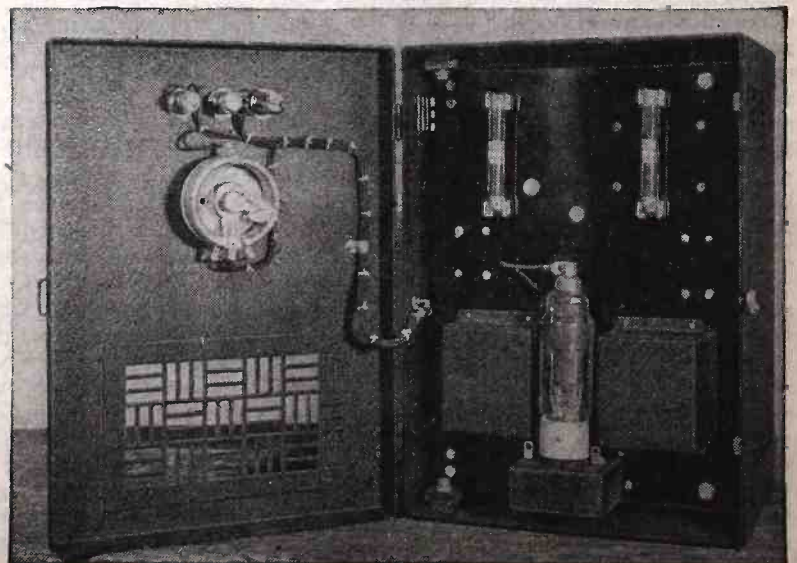

the transformer to which it is attached, and the two voltages are at right angles.

We find the voltage between center tap and the junction of the resistor and condenser is exactly 20—just what it would have been had the grid been connected to either end of the transformer. The right angle at which the line representing the grid voltage points with respect to the transformer voltage line indicates that the two voltages are just 90 degrees out of phase—in other words that the grid voltage will cross the zero point one-quarter of a cycle after the anode voltage.

Figs. 3-d and 3-e show what happens if the resistor or the condenser offers the greater opposition to current. In Fig. 3-d the reactance is about four times the resistance, and in 3-e the resistance roughly four times the reactance. In both cases the voltage between grid and cathode remains the same. The phase angle is the only thing that changes, moving toward the end of the transformer to which the grid is more closely connected. This is what we should expect, even though it was not obvious that the voltage between grid and cathode would remain the same, no matter what the combination of resistance and reactance in the circuit. If we draw a circle centered on the mid-point of the transformer voltage and with a radius representing the voltage of one-half the winding, all the points that can be obtained any combination of resistance and reactance fall on that circle.

#### INDUCTANCE CIRCUITS

It is not usually practical to use a continuously variable condenser at 60 cycles. Therefore we cannot get smooth regulation over 180 degrees with the combination just described. The resistor can be varied continuously—the condenser generally cannot. This is not important in some applications—it may be necessary to shift the phase over only a part of the cycle. In others, several condensers can be cut in or out with a tap-switch, putting in parallel as many as may be needed to give the required impedance.

Iron-core inductors are more easily varied at low impedances. Inductance works as well as capacitance in a control circuit. The reactance can readily be varied by using a core which can be pushed in or drawn out of the coil. Phase shifts approaching 180 degrees can be approached with a circuit using a variable inductance and a variable resistance.

Other methods of control use inductances. Where three-phase current is used, a device of the Selsyn type makes an excellent phase-shifter. A Selsyn is one of the common trade names for a transformer with a secondary which can be rotated to any desired position with respect to the primary for the purpose of producing. As the physical position of the two windings is varied, so is the phase relationship of the supply voltage and that induced in the secondary. Thus any desired amount of lead or lag may be obtained.

Other circuits use saturable inductors or transformers, or vacuum tubes. These are simply variations of the resistance-reactance combination, the special components being employed to get results which could not be obtained from ordinary resistors or inductors.

So far, nothing has been said about ignitron firing methods. While this tube can be fired by systems which store the energy in a condenser, to be released at the right moment, a considerable amount of power is required to fire an ignitron. The common method is to use a thyatron with a conventional control, and to use the plate current of the thyatron to fire the larger ignitron. A welding timer which uses this system is shown in the photo.

# NOW WESTON MODEL 785 INDUSTRIAL CIRCUIT TESTER!

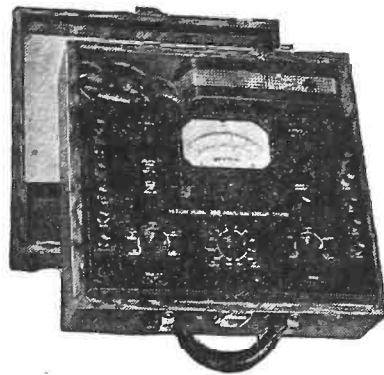

**Tests Insulation  
and Cable Cover-  
ing Resistance  
Values as Well!**

With this new, compact unit which fits into the spare compartment and connects into the ohmmeter circuit with a pair of leads, Model 785 now provides for resistance measurements up to a value of 900 megohms. Thus the broad range coverage of this versatile maintenance tool now is as follows:

**DC VOLTAGE . . .** 0-1/10/50/200/500/1000 volts — 20,000 ohms per volt. (\*5000 volt range with external multiplier.)

**AC VOLTAGE . . .** 0-5/15/30/150/300/750 volts — 1000 ohms per volt.

**DC CURRENT . . .** 0-50 microamperes, 1/10/100 milliamperes, 1 ampere and

10 amperes (\*ranges above 10 amperes with external shunts).

**AC CURRENT . . .** self-contained ranges 0-5/1/5/10 amperes (\*higher ranges with an external current transformer).

**RESISTANCE . . .** 0-3000, 0-30,000, 0-300,000 ohms, 0-3 megohms, 0 to 30 megohms (self-contained batteries). 0-900 megohms (\*with compact Model 792 Resistance Tester shown in illustration).

*\*Extra equipment on special order.*

For complete facts on Model 785 write Weston Electrical Instrument Corp., 599 Frelinghuysen Ave., Newark, N. J.

## WESTON Instruments

### THIS MACHINE DESTROYS VOLUME CONTROLS

**E**FFICIENCY of rheostat-potentiometers is assured by this newly-developed testing device which subjects production models to severe "proving" operations before leaving the factory. Designed to subject the rheostat-potentiometer to a lifetime's effective operation at a greatly accelerated rate, the device, known as the Continuous Rotation Testing Machine has been evolved by DeJur-Amsco to improve the performance standards of its components.

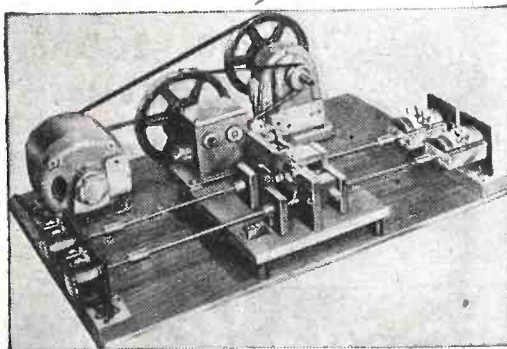

On one-half cycle, the wiper travels from minimum to maximum resistance and reverses in the next half cycle, simulating manual operations at a continuous high rate of speed which is, in itself, more abusive than normal operations would be. New models and spot checks are run as many as 200 hours at rates stipulated in American Standards Association specifications. Upon examination—and the parts are completely disassembled and examined—they have required no repair or adjustment.

This type of apparatus permits the en-

gineer to study the effects of continuous day in, day out performance under normal, as well as abnormal, conditions. Oftentimes, when disassembling and examining the units for wear or electrical characteristic changes, improvements are suggested and incorporated into the next models which are in turn re-tested.

In applying electronic power to generate heat in industrial materials, engineers are putting to constructive use an electrical phenomena that caused many headaches for amateur set builders in the early days of radio, according to Merrill F. Chapin, of the RCA Victor Division of the Radio Corporation of America.

Speaking at a meeting of the Plastics Forum at the Franklin Institute in Philadelphia, Chapin pointed out that every "ham" operator has worried about power losses, particularly in the tuning condensers and to some extent in the coil forms of his sets. "The more material we had lying around in our coils or in the electrostatic field of our condensers," he recalled, "the more power we lost in the form of heat generated in the insulating materials."

"Now, with electronic power generators such as those which RCA is supplying to war industries today," he said, "we are purposely heating insulating materials such as wood, plastics, textiles, and resins, making use of the loss factor of these materials. As compared with other methods of heating, the electronic method is improving product quality and cutting process time from hours to minutes in many applications."

# ELECTRICITY

## For Any Job Anywhere

For a dependable source of electricity on projects remote from commercial power, Onan Electric Plants are proven leaders in the field. More than half of the Armed Forces' total requirements for Power Plants are built by Onan.

Gasoline driven—single-unit . . . . Compact design . . . . sturdy construction . . . . sound engineering . . . . Suitable for mobile, stationary or emergency applications.

Over 65 models, ranging in sizes from 350 to 35,000 watts. 50 to 800 cycles, 115 to 660 volts, A.C. . . . . 6 to 4000 volts, D.C. . . . . also dual A.C.-D.C. output types.

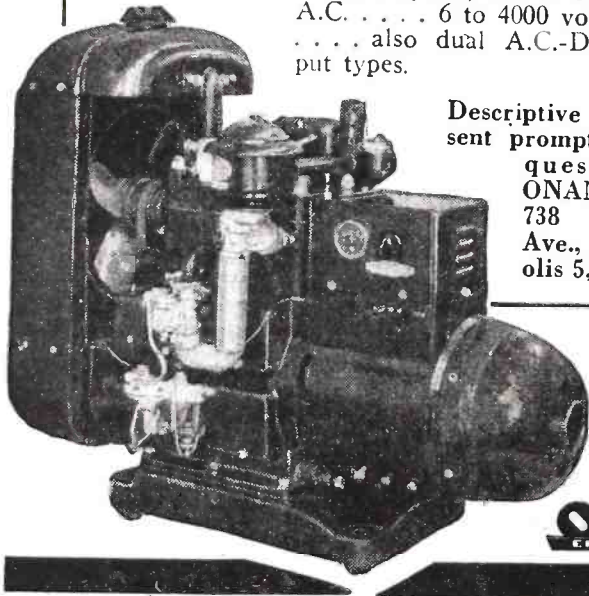

Descriptive literature sent promptly on request. D. W. ONAN & SONS, 738 Royalston Ave., Minneapolis 5, Minn.

**ONAN**  
ELECTRIC PLANTS

## HIGH-SPEED ELECTRONIC SORTER

MUCH greater speed in the sorting and inspection of tiny contact assemblies produced at General Electric's Schenectady works has been made possible through the development of an electronic sorting table which routes the assemblies into three different chan-



## STEEL CABINETS

Now Available with Popular  
**G-C Dial Belt Kits**

G-C Woven Fabric Belts are the finest replacements for all sets. Easy to install — no slipping — no stretching — no adjustments. A perfect fit every time.

Kits Available  
with 25, 50,  
100, 200 or  
300 Belts.

Order From Your  
Radio Parts Jobber



STEEL  
CABINET AND  
MEASURING DEVICE

**FREE!** You Pay  
For Belts Only

**GENERAL CEMENT MFG. CO.**  
ROCKFORD, ILLINOIS



nels depending on whether they are too high, too low, or within the tolerances.

Previously, the contact assemblies, each almost small enough to require handling with tweezers, were sorted and inspected by hand. Each assembly was checked with a needle micrometer to determine whether it was oversize, undersize, or within the tolerances, and then sorted accordingly. Ordinary automatic sorting apparatus could not possibly be applied to such small pieces, which lacked the size and mass necessary to actuate any of the standard devices.

The specially designed sorting table incorporates General Electric's recently announced new electronic relay and a factory-constructed "contact head." Each assembly is fed onto a 45-degree slide which is part of the contact head. About halfway down the slide, the assembly comes to a contact point located at a preset height. If the assembly touches the point, it is oversize, and the contact made closes the grid circuit of the electronic relay's electronic tube, which in turn energizes an electromagnetic relay, another part of the electronic relay. A solenoid is next energized, sending the assembly down a chute into a container for oversize parts.

A short distance beyond the first point a second contact point is set at standard height less tolerance. Since oversize assemblies have already been eliminated at the first contact point, parts touching the second point are within acceptable limits and are "shot" down another chute.

Undersize assemblies do not touch either point and slide undisturbed to a third tray.

Projected American short-wave broadcast stations number 36, thirty of which are already in operation. Construction of the remaining six is being carried out under the direction of the OWI.

### Attention Radio Servicemen

Many hard to get items.  
Send post card for new price list.

**JOHN A. COX**  
**WHOLESALE RADIO SUPPLIES**

557-7th Street, Parkersburg, W. Va.

### Guaranteed Rebuilt Radio VIBRATORS—\$1.00 ea.

Send old vibrator. For very prompt delivery, enclose remittance and return postage. We rebuild any make or kind of vibrator or relay. Vibrator packs rebuilt also. Send your old vibrator to  
**BEST VIBRATOR CO., Box 5802-Z, Cleveland 1, O.**



## WORLD-WIDE STATION LIST

(Continued from page 32)

Mc.	Call	Location and Schedule
9.750	WKJL	NEW YORK CITY; North Africa beam, 5:15 to 7 am; 3:30 to 8 pm.
9.760	DKSA	"DEUTSCHER KURZWELLENSENDER ATLANTIK."
9.785	OTC	LEOPOLDVILLE, BELGIAN CONGO; 5:45 to 6:35 pm; 8:15 to 8:45 pm; other times.
9.825	GRH	LONDON, ENGLAND.
9.833	COCM	HAYANA, CUBA.
9.833	XPRA	KUNMING, CHINA.
9.840	—	"HUNGARIAN NATIONS RADIO"; heard Sundays 3:15 to 3:26 pm.
9.855	KWIX	SAN FRANCISCO, CALIF.; Australian beam, 4 to 6:30 am.
9.860	EAQ	MADRID, SPAIN; 1 to 3 pm; 6:30 to 7:15 pm; 7:20 to 8 pm.
9.865	—	MOSCOW, USSR.
9.880	CR7BE	LOURENCO MARQUES, MOZAMBIQUE.
9.880	—	MOSCOW, USSR.
9.897	WKRD	NEW YORK CITY; European beam, 9 to 11:30 pm; 2:15 to 6 am.
9.897	KROJ	LOS ANGELES, CALIF.; Australian beam, 4 to 9 am.
9.897	WKRX	NEW YORK CITY; North European beam, 6 to 8:45 pm.
9.905	—	RADIO DAKAR, FRENCH WEST AFRICA; heard 2:45 to 5 pm.
9.930	—	ATHENS, GREECE; Soldaten Sender Miffle Meer; heard 2 to 7 pm.
9.958	HCJB	QUITO, ECUADOR; 9 to 9:45 am; as late as 11:30 pm.
10.000	WWV	BELTSVILLE, MARYLAND; U. S. Bureau of Standards.
10.040	—	BERLIN, GERMANY; heard evenings till about 9 pm.
10.045	XUW	CHUNGKING, CHINA.
10.050	SUV	CAIRO, EGYPT; heard calling New York occasionally on Sundays.
10.050	XBHX	MEXICO CITY, MEXICO.
10.065	MTCY	MANCHUKUO.
10.080	—	MADRID, SPAIN; heard calling New York.
10.130	HH3W	PORT AU PRINCE, HAITI; 1 to 5 pm; 7 to 11:30 pm.
10.22	PSH	RIO DE JANEIRO, BRAZIL.
10.260	XGAP	PEIPING, CHINA.
10.285	ZNR	ADEN, ARABIA.
10.338	—	BERN, SWITZERLAND; North America beam, 3:45 to 4:15 pm except Saturdays; to South America, 7:30 to 9 pm.
10.380	—	STATION DEBUNK; Station of the All Free.
10.400	YPSA	SAN SALVADOR, EL SALVADOR; heard evenings.
10.445	—	MOSCOW, USSR.
10.48	COCH	HAYANA, CUBA.
10.543	DZD	BERLIN, GERMANY.
10.620	KES3	SAN FRANCISCO, CALIF.; N. E. I. beam, 1 to 6:30 am.
10.75	—	RIO DE JANEIRO, BRAZIL.
10.840	KWV	SAN FRANCISCO, CALIF.; Australian beam, 2 to 5:15 am; N. E. I. beam, 5:30 to 7 am; 4:30 to 6 pm; Sundays, 4:45 to 6 pm; off on Wednesdays.
11.760	DHE4B	PODIEBRAD, BOHEMIA; on at 6 pm; sign off time unknown.
11.840	DHE4B	PODIEBRAD, BOHEMIA; on at 6 pm; sign off time unknown.
11.900	KWIX	SAN FRANCISCO, CALIF.; South American beam, 6:45 pm to midnight.
15.290	KGEI	SAN FRANCISCO, CALIF.; South American beam, 5 pm to 12:45 am.
15.290	KGEX	SAN FRANCISCO, CALIF.; South America beam, 11 am to 5 pm.
17.760	KWID	SAN FRANCISCO, CALIF.; South America beam, 4 to 7:45 pm.
17.955	WLWL	CINCINNATI, OHIO; Central African beam, 10:45 am to 1:15 pm; 1:30 to 5:15 pm.
18.160	WNRA	NEW YORK CITY; European beam, 10 am to 5:15 pm.
18.380	PMA	BANDOENG, NETHERLAND INDIES; 8:45 to 11:30 pm.

Combination of the electron microscope with the electron spectroscopy provides a means for analyzing areas less than one-hundred-millionth square inch. The apparatus consists of a fine slit at the bottom of the electron microscope, coated with fluorescent material. The operator directs onto the slit the part of the image to be analyzed by the electron spectroscopy, while observing the image of the particle—enlarged many times—through the regular eyepiece of the instrument.

## BARGAIN BULLETIN

### RADIO and ELECTRICAL PARTS

SAVE Time—Money—Worry!  
10,000 Items—Ready for shipment.  
EXTRA SPECIAL—Sensational Vibrator Supply for Farm Radios. Complete and ready to install. Priced right.  
FACTORY OUTLET for Job Lots and distress items. First come—first served.

BIG BARGAIN LIST—just off the press.

Write for YOUR copy TODAY.  
**McGEE RADIO & ELECTRIC CO.**

R-944, 1225 McGee St., Kansas City, Mo.

## ELECTRICITY



### Prepare for a Peace Time Future

Electricity offers you opportunities for the best jobs today—with a real peace time future. "Learn by Doing," on real machinery. Earn while learning. Right now I'm offering extra training in Industrial Electronics at no extra cost. Lifetime employment service after graduation. Get all-around practical training at Coyne in 12 weeks. If you are short of money I'll finance your training. Mail coupon now for Free Book and all details. No obligation and no salesman will call. I want to send you the facts and you decide.

We also have facilities for men with physical disabilities. Write for details.

H. C. LEWIS, President, COYNE ELECTRICAL SCHOOL  
500 S. Paulina St., Dept. 74-78, Chicago 12, Ill.

NAME \_\_\_\_\_  
ADDRESS \_\_\_\_\_  
CITY \_\_\_\_\_ ZONE \_\_\_\_\_ STATE \_\_\_\_\_

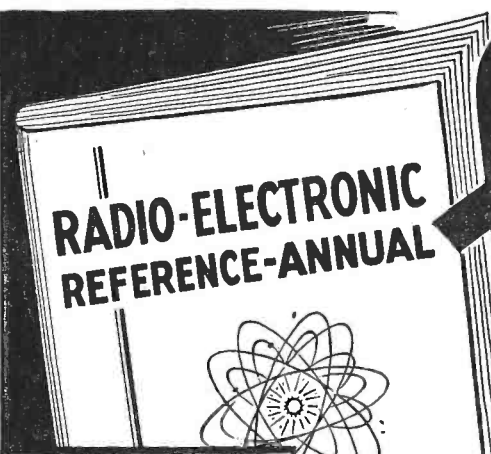

### PARTIAL CONTENTS RADIO - ELECTRONIC REFERENCE ANNUAL

**ELECTRONIC THEORY AND GENERAL PRACTICE**  
Is thoroughly covered in this book in easy-to-grasp language. Among the articles on this subject are: What You Should Know About Electronics—Electronic Tubes for Servicemen—The Electronic Solovox, its theory and action—and the Photoelectric Phonograph Pickup, the principles underlying its operation.

**ELECTRONIC DEVICES YOU CAN BUILD**  
Among the interesting and easily constructed devices selected are the following: Compact Hearing Aid—Oscillaplex—Automatic Key and Code Machine—Electronic Relays, Capacity and Light Operated. High Frequency Radiotherapy, a complete home apparatus—and many other timely types of electronic apparatus.

**RADIO CONSTRUCTION**  
Many well-illustrated, how-to-do-it articles, such as: Phono Oscillators, several types, adapted to playing records through your radio with a simple record player—T.R.F. Sets—Superheterodynes—Power packs for Portable Receivers—making it possible to use your battery portable on the electric light line—A two-tube Super Midget Amplifier, which is a palm-of-the-hand public address system—and many others.

**SOUND AND RECORDING**  
Including detailed instructions on constructing: High-Fidelity Amplifier—Exponential Horn with perfect reproduction down to 50 cycles—Electronic Expander-Compressor—Also the Roberson Technique—Semi-Pro Recording—Electronic Bass—and Treble-Expanding Circuits—Equalizers, etc.

**TEST INSTRUMENTS**  
A complete line including: A Tube Checker with universal hookup; can check any tube regardless of the prong to which its elements are brought out—Compact Multimeter; 18 ranges of voltage, current and resistance on an 11-point, 0-range switch—A Three Tube Signal Tracer, capable of checking R.F., I.F., and audio circuits—A Condenser Analyzer which measures both capacity and checks leakage—and an Electron-Ray Voltmeter which dispenses with hard-to-get milliammeters, using a 6ES tube instead.

**SERVICING**  
Articles on servicing supply a multitude of methods and useful ideas, including: Dynamic Testing with Signal Generator—Modernizing a Test Set—Calibrating UHF Oscillator—And countless other hints for ironing out kinks in your servicing problems.

1944



**FREE—if you  
subscribe now to**



Are you asking yourself: "What's next in Radio and Electronics?" What mysterious inventions are brewing in radio research laboratories? What effect will these wartime secret inventions have on peacetime conditions? Will the scientists take me into new, unfamiliar fields, requiring special technical education?

### Keep Posted With Radio-Craft

Radio is once again at the crossroads! All must become students again of a science that has experienced a marvelous rebirth through ELECTRONICS. The question about these wartime secret inventions now racing the near and distant future now answered through your mind will be answered step by step in the forthcoming issues of RADIO-CRAFT.

### You Need This Free Reference Annual, Too!

You can't plan intelligently ahead—you can't grasp the new—until you have thoroughly mastered the tried and accepted present-day radio developments. And that is where the REFERENCE ANNUAL comes to your aid. This fact-packed book is THE radio man's digest. It's the spark that bridges the gap between the RADIO-ELECTRONIC WORLD OF TODAY and the COMING POST-WAR WORLD.

And think of it—you can get it absolutely free and postpaid by subscribing to RADIO-CRAFT now—but you must act quickly as war-paper shortage compels us to limit the printing. If you are already a subscriber we can extend your subscription.

### CUT OUT AND MAIL

RADIO-CRAFT  
25 West Broadway  
New York 7, N. Y.

Be sure to use coupon or mention Free Reference Annual when ordering. No billing.

Gentlemen:  
I want to take advantage of your Special Time Limit Offer for your RADIO-ELECTRONIC REFERENCE ANNUAL—1943-1944, which you will send me ABSOLUTELY FREE and PREPAID in connection with my subscription to RADIO-CRAFT and Popular Electronics for the period checked below. No billing on this Special Offer.

I enclose my remittance of \$ \_\_\_\_\_  
 1 Yr. \$2.50  2 Yrs. \$4.50  3 Yrs. \$6.00  
 This is a new order  Renewal  Extension

Name \_\_\_\_\_  
Please print clearly  
Address \_\_\_\_\_  
City \_\_\_\_\_ State \_\_\_\_\_  
Postal Dist. No. (if any)  
(Canadian 50c extra, Foreign 75c extra per year. Send by International Money Order.)

### TIME LIMIT OFFER

RADIO-CRAFT  
WITH FREE COPY  
RADIO-REFERENCE  
ANNUAL

1 Year \$2.50  
2 Years \$4.50  
3 Years \$6.00

If you are already a subscriber we can extend your subscription if you will check "Extension" box.



## TECHNICAL PERSONNEL WANTED

### IS YOUR OPPORTUNITY HERE?

Think this over carefully. Where do you go from the spot you're in now? Are your surroundings friendly and full of promise for the future? Consider now the place you might fill in the electronic industry leadership assured to the fine staff of engineers, scientists, technicians at NATIONAL UNION RADIO CORPORATION. We're all young in years and ideas though most of us are old in electronic experience. We enjoy working together. We know we're going places! We're inviting you to join us if you have the qualifications. If you're looking for a success pattern for your future, it may be here with us at National Union. Find out! Come in and talk it over or write us!

#### NATIONAL UNION WANTS:

- \* **QUALITY CONTROL ENGINEER AND SENIOR TUBE ENGINEERS**—These men **MUST** have executive ability and extensive experience with radio tube manufacture. The pay and opportunities are commensurate with your ability.
- \* **COMMERCIAL ENGINEERS**—Men with pleasing personalities, initiative and a knowledge of vacuum tube applications.
- \* **QUALITY CONTROL MEN**—Statistical Training is chief requirement, though a knowledge of vacuum tubes will help.
- \* **JUNIOR ENGINEERS—MEN or WOMEN**—If you have a college degree in Physics, Electrical Engineering, Mathematics or Chemistry and are the type of young person who is able to "go places," you'll be starting with your best foot forward if you are accepted at National Union Radio Corporation.
- \* **FOREMEN and ASSISTANT FOREMEN**—Men with foremanship experience in exhaust, stem or grid operations in radio tube manufacture.
- \* **TECHNICIANS**: Maybe you've been repairing radios, maybe you've gained a knowledge of circuits by working on test equipment. It makes no difference either way if you have the "know how" of circuits write us about the opportunities we have to offer!

#### WOMEN!

We have a number of fine young women engineers with us now. We need more. If you have a degree in Electrical Engineering, Physics, Chemistry or Mathematics and are seeking career opportunities, investigate.

*Phone or Write*

DR. L. GRANT HECTOR, Director of Engineering  
**NATIONAL UNION RADIO CORPORATION**  
**RESEARCH LABORATORIES**

PLANE ST. AT RAYMOND BLVD., NEWARK 2, NEW JERSEY

**WMC RULES OBSERVED**

#### ELECTRICAL ENGINEERS RADIO TECHNICIANS

FOR DESIGN, DEVELOPMENT  
AND PRODUCTION WORK  
POST WAR OPPORTUNITY

**ALLEN D. CARDWELL MFG. CORP.**  
81 Prospect St. Brooklyn

The Army Airway Communications System and Army Communication Service set up in three months the triangular radio network necessary for the successful opera-

tion of the new United States air bases in Russia, Strategic Air Force Headquarters disclosed recently.

The project involved the selection of personnel to operate the Russian base installations, getting weather equipment from England, Iceland and Africa and transporting men and equipment to Russia and Italy.

**SHARE THE PRINTED WORD**

## Wanted ENGINEERS

- Radio
- Chemical
- Electrical
- Electronic
- Mechanical
- Metallurgical
- Factory Planning
- Materials Handling
- Manufacturing Planning

Work in connection with the manufacture of a wide variety of new and advanced types of communications equipment and special electronic products.

*Apply (or write), giving full qualifications, to:*

**C. R. L.**  
**EMPLOYMENT DEPARTMENT**

**Western Electric Co.**

**100 CENTRAL AV., KEARNY, N. J.**

Applicants must comply with WMC regulations

### ENGINEERS WANTED as APPLICATION ENGINEERS

Exceptional opportunity for several bright men, graduate engineers or equivalent, with imagination and ability to prove equipment and application. Radio, ultra high frequency or communication experience an asset. These positions provide excellent post war possibilities with one of the largest communication manufacturers in the world.

*Write in full details, age, experience, education to Personnel Manager.*

**FEDERAL TELEPHONE & RADIO CORP.**  
The Mfg. Unit of the I. T. & T.  
39 Central Ave., East Newark, N. J.

### ENGINEERS DESIGNERS

**ELECTRICAL, MECHANICAL,  
RADIO, ACOUSTICAL**

For Research and Development Laboratory of large company fully engaged in war work manufacturing aircraft accessories. Activity includes electronic control equipment, continuous recorders, special radio devices, etc.

Excellent post-war opportunities. Laboratory located in central Manhattan. All replies strictly confidential. Write full details, Box 550 Equity, 113 W. 42nd St., N. Y. C.

# ENGINEERS . . . .

## Are You Concerned With YOUR POST WAR FUTURE ?

The Federal Telephone & Radio Corporation, the manufacturing unit of the International Telephone & Telegraph Corporation with its multiple business activities extending to all parts of the civilized world, will accept applications from experienced men for immediate employment with almost limitless post war possibilities. These positions should interest those with an eye to the future and whose interest lies in forging ahead with this internationally known organization whose expansion plans for post war are of great magnitude covering all types of radio & telephone communications. Advancement as rapid as ability warrants. Majority of positions are located in the New York area!

We need the following personnel! Men with long experience or recent graduates considered.

- ENGINEERS
- ELECTRONICS
- ELECTRICAL
- RADIO
- MECHANICAL
- CHEMICAL
- TRANSFORMER DESIGN
- SALES AND APPLICATION ENGINEERS
- PHYSICISTS
- DESIGNERS
- DRAFTSMEN
- TOOL DESIGNERS
- TECHNICAL WRITERS

### Look Ahead With Federal!

If inconvenient to apply in person, write letter in full, detailing about yourself, education, experience, age, etc., to Personnel Manager.

**FEDERAL TELEPHONE & RADIO CORP.**

39 Central Avenue

EAST NEWARK

NEW JERSEY

## Your Future

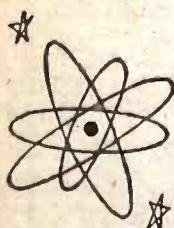

- AS A
- Radio Engineer
- Assistant Engineer
- Layout Draftsman
- Laboratory Assistant
- Quality Tester
- Analyser
- Phaser

### depends on what you do now!

Why not find out what Motorola offers you in future security, rapid advancement, recognition, and salary increases. The positions open are in Development, Specifications, Production, Engineering and Test Equipment. List your qualifications on one side of a sheet of paper. Name the position you want. We'll send you the details. Get your letter in the mail today.

**Motorola Radio**  
GALVIN MFG. CORPORATION, 4545  
AUGUSTA BLVD., CHICAGO 51, ILL.

## DESIGNER

A Central New England manufacturer employing over 1000 people needs Draftsman-Designer on telephone and signaling (mechanical) apparatus.

Knowledge of die-casting and plastic applications desirable.

*WMC Regulations Prevail*

**BOX 804**

c/o Radio-Craft

25 West Broadway, New York 7, N. Y.

## DEVELOPMENT ENGINEERS

Mechanical and electrical. Graduate or equivalent training. Required for development work in the following branches:

1. Electro-mechanical devices, communication systems. Must be interested in development and familiar with magnetic circuits.
2. Measuring and control instruments. Background should be in electrical engineering, including electronics.

*Statement of Availability Required.*

**BOX 802 c/o Radio-Craft**  
25 West Broadway, New York 7, N. Y.

## STATISTICIAN WANTED

Preferably a B.S. or B.A.  
in ECONOMICS

Must have some background in market research and writing reports.

An excellent post war future for a capable man in the radio division of this internationally known company.

*Essential workers need release*

**FEDERAL TELEPHONE & RADIO CORP.**

The Mfg. Unit of the I. T. & T.  
39 Central Ave., East Newark, N. J.

## ELECTRONIC

ENGINEERS  
TECHNICIANS  
DESIGNERS  
DRAFTSMEN  
TUBE TECHNICIANS

EXCELLENT OPPORTUNITIES  
IN A MAJOR POST-WAR FIELD!

Openings available at our Research Laboratories and Electronics Manufacturing Unit. Leaders in the design and development of vital electronic equipment for the Armed Forces.

*Essential workers need release.*

Write, stating Experience, Education, Draft Status, Salary. Include snapshot if available. Or apply to

## SPERRY

GYROSCOPE COMPANY, INC.  
RESEARCH LABORATORIES  
STEWART AVE. & CLINTON RD.  
GARDEN CITY, NEW YORK

## FIELD SERVICE ENGINEERS

For Domestic and  
Foreign Service

Must possess good  
knowledge of Radio

*Essential workers need release.*

**HAZELTINE  
ELECTRONICS CORP.**

58-25 Little Neck Parkway  
Little Neck, Long Island

The FCC recently announced the resignation of its assistant chief engineer in charge of broadcasting, Philip F. Siling, who has left the Commission to become engineer in charge of the central frequency bureau of the RCA.

# THE NATION'S CHOICE

..for Everything in RADIO and ELECTRONICS



**FREE**  
Complete..  
Up-to-date  
BUYING GUIDE

Save Time!  
Call  
**ALLIED**  
First!

REPAIR and REPLACEMENT PARTS AVAILABLE without priority

Thousands use Allied's nation-wide service. Centralized here are today's largest and most complete stocks under one roof. Over 10,000 items from all leading manufacturers . . . for the Armed Forces, Radio Training, Laboratories, Industry and Service Replacements. Our experienced staff simplifies procurement—expedites delivery. Call ALLIED first . . . for everything!

Write, Wire, or Phone Haymarket 6800



## 6 Radio Books for 75c

- |  |     |  |     |
|--|-----|--|-----|
| Dictionary of Radio Terms. No. 37-751  | 10c | Radio Data Handbook. No. 37-754        | 25c |
| Radio Circuit Handbook. No. 37-753     | 10c | Radio Builders Handbook. No. 37-750    | 10c |
| Radio Formulas & Data Book. No. 37-752 | 10c | Simplified Radio Servicing. No. 37-755 | 10c |
| All Six Books No. 37-799 . . . . . 75c |     |  |     |
- Write for Quantity Prices

ALLIED RADIO CORP., Dept. 2-K-4  
833 W. Jackson Blvd., Chicago, Ill.

Please send following books (.....c enclosed)  
 FREE  37-750  37-752  37-754  
 Buying Guide  37-751  37-753  37-755  
 No. 37-799 (All Six Books)

Name.....  
 Address.....  
 City..... State.....

**ALLIED RADIO**

# TECHNOTES

## ... HUM BUCKING COILS

In replacing speaker cones or hum bucking coils, it is necessary that the proper connections be made to secure proper hum bucking action. A simple method is shown in the illustration. Apply AC to the field coil. An AC voltmeter is connected in series with the voice and hum bucking coils.

Reverse the voice coil leads and note which connection gives the least AC voltage, this being the correct one. Use a low voltmeter scale.

The line may be connected directly to the field if the latter has a high resistance (over 750). Otherwise a resistance of about 1000 to 2000 ohms should be wired in series with the field. Use a 10 watt resistor. Field coils may take quite a bit of current and get warm during the test, but ordinarily the complete check requires a matter of seconds, so that no damage can be done.

JOHN B. ENGLEMAN,  
Sunter, S. Car.

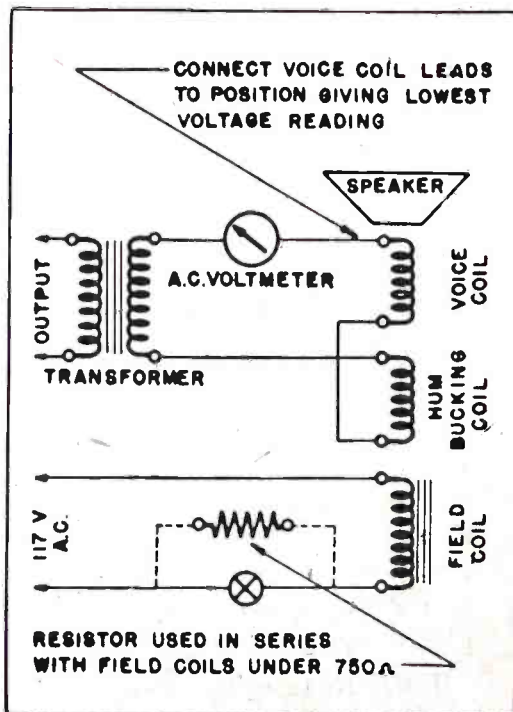

## ... REPLACING OZ4 TUBES

The OZ4 may be replaced with a 6ZZY5. The latter tube uses a filament which must be wired in to terminals 2 and 7.

ROY L. LAIR,  
Tuscumbia, Ala.

## ... BUICK SONOMATIC 980690 AND 980691

Here is a tip that may be of help to fellow Servicemen.

Have had three of these sets in with complaint that they blow fuses. Replaced the vibrator and still had this trouble. Found that a .5 condenser inside the power transformer case was defective. This condenser is not shown as being inside this case. It is on the center of the 6V side of the power transformer. Remove bottom of the case and dig out old condenser, then replace with good one of equal size and voltage rating, and refill with wax. There is also a choke inside this case.

M. L. NIELSEN,  
Spencer, Iowa.

## ... CANADIAN TUBE REPLACEMENTS

In sections near the border there sometimes exists replacement difficulty for certain Canadian tubes, sometimes because of a lack of information rather than a lack of proper tubes. These tubes are used in Canadian Rogers, Majestic and DeForest (DeForest-Crosley) receivers, and are manufactured by Canadian Radio Corporation.

One tube series is the Rogers "S" or spray-shield type. These are covered with an aluminum colored coating and are non-oculal glass tubes. With few exceptions they are identical to standard tubes without shield, except that those used in R.F. and detector circuits will require a close fitting shield when replaced with standard equipment. Examples are:

ROGERS	STANDARD
1C6S	1C6
24S	24
56S	56
47S	47
58S etc.	58 etc.

Exceptions are:

87S	77	or 6C6 (with shield)
88S	78	or 6D6
86S	76	or 37
89RS	6G7	37
51S	35	

The 6H7S is a combination power pentode and high-mu triode with no direct replacement.

The second type consists of "Metal-Spray" octal base glass tubes, with black metallic coating. This "M" series usually has an equivalent standard metal tube or octal base glass tube. For R.F. circuits a glove-type shield should be used.

Examples:

ROGERS	STANDARD
6K7M	6K7 — 6K7-G
6J8M	6J8 — 6J8-G
12A8M	12A8 — 12A8-G
12A8MT	12A8-GT

The "T" is used in some tubes of later production to represent the smaller type of bulb.

Exceptions:

6A7M	6A8 — 6AG8-G
41M	6K6G
75M	6B6G — 6O7
86M	6C5 — 6P5-G
12B6M	12Q7 — 12Q7-GT
88M	6K7 — 6K7-G
6B7M	(use 6B8 and interchange socket terminals 4 and 6)
6H7M	(power pentode and high-mu triode. No direct replacement)

The third type includes a few exclusive Rogers types, as follows:

2X3—Half wave rectifier octal, pins 2 and 8 are filament, 4 for plates. The filament requires 2½ volts, but since two tubes are always used, a total of 5 volts is required. A single 5Y4-G or 5Y3-G can replace, with a few wiring changes.

2Y3—Half wave rectifier, heavy duty, same base as 2X3, also 2½-volt filament and used in pairs. A single 5T4 or 5U4G will substitute.

20J8M—Octal base metal spray tube, with 20-volt, .15-ampere heater, other characteristics similar to 6J8G. Possibly a 12A8GT with extra filament ballast might be satisfactory as replacement.

W. H. BRAKES,  
Westminster, B. C.

# FOR SALE HARD-TO-GET ITEMS

All items are brand new, except where indicated. ALL are in PERFECT WORKING ORDER. In many cases, the parts alone total more than the price we are asking. Satisfaction guaranteed or your money back. ORDER FROM THIS PAGE. Use our convenient coupon. Include sufficient extra remittance for parcel post charges, otherwise order is sent express collect. Any excess will be refunded. All C.O.D. shipments require 20% deposit. No C.O.D. shipments on orders for less than \$5.00. If full remittance accompanies order deduct 2% discount. Send money order, certified check, or new U. S. stamps. No C. O. D.'s to foreign countries.

## ULTRA MAGNET

LIFTS MORE THAN 20 TIMES ITS OWN WEIGHT

### LITTLE GIANT MAGNET

Lifts 5 lbs. easily. Weighs 4 oz. Made of ALNICO new high-magnetic steel. Complete with keeper. World's most powerful magnet ever made. The experimenter and hobbyist will find hundreds of excellent uses for this high quality permanent magnet. Measures 1 3/4" x 1 1/4" Shp. Wt. 5/8 lbs.



ITEM NO. 159  
YOUR PRICE ..... \$1.25

## GENUINE MICROPHONE TRANSMITTERS

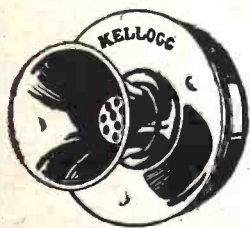

These are regular "telephone transmitters" of the type used on wall telephones. Taken from a large telephone supply company's overstock, these fine mikes offer a grand opportunity to obtain a splendid unit for little more than the price usually asked for a simple "microphone button."

The amateur experimenter and telephone mechanic will find a variety of uses for these excellent microphones. They work perfectly on 2 dry cells. Can be used on P.A. systems for voice transmissions, in call systems and intercommunications sets. With telephone receivers (radio headphones will do) they may be made into short-line telephone circuits, such as house-to-house or farm-to-farm 'phone lines. You can use them to talk through your own radio, or as concealed dictaphone pick-up units for listening to conversations in a distant room or building. The telephone mechanic will find them useful replacements on battery-operated rural telephone lines.

THESE ARE GENUINE TRANSMITTERS. MADE BY KELLOGG, WESTERN ELECTRIC AND STROMBERG-CARLSON, excellent in appearance and operation. A remarkable value, and one seldom offered in these times. Shp. Wt. 1 lb.  
ITEM NO. 160  
YOUR PRICE ..... \$1.50

## AMAZING BLACK LIGHT!!

Powerful 250-Watt Ultra-Violet Source



The best and most practical source of ultra-violet light for general experimental and entertainment use. Makes all fluorescent substances brilliantly luminescent. No transformers of any kind needed. Fits any standard lamp socket. Made with special filter glass permitting only ultra-violet rays to come through. Brings out beautiful opalescent hues in various types of materials. Swell for amateur parties, plays, etc. to obtain unique lighting effects. Bulb

only. Shp. Wt. 1 lb.  
ITEM NO. 87  
YOUR PRICE ..... \$2.45

## WATTHOUR METER

Completely overhauled and ready for immediate service. Designed for regular 110-volt, 60 cycle 2-wire A.C. circuit. Servicemen use it in their shops to check current consumption of sets, soldering irons, etc. Keeps costs down. If dismantled, the parts alone would bring the price. The elaborate rear train could be used as a counter on machines of various kinds. Simple to install; 2 wires from the line and 2 wires to the load. Sturdily constructed in heavy metal case. 8 1/2" high, 6 1/4" wide, 5" deep. Westinghouse, G. E. Ft. Wayne, Sangamo or other available make. Shp. Wt. 14 lbs.



ITEM NO. 33  
YOUR PRICE ..... \$5.95

## LIMITED QUANTITIES! PROMPT SHIPMENTS!

It's Easy to order—Clip Coupon—Order from This Page—No Catalog Sent. MAIL TODAY—NOW!  
(See Corresponding Ad Page 50)

### HUDSON SPECIALTIES CO.

40 West Broadway, Dept. RC-10-44, New York 7, N. Y.

I have circled below the numbers of the items I'm ordering. My full remittance of \$..... (NO C.O.D. include shipping charges) is enclosed (NO C.O.D. ORDERS UNLESS ACCOMPANIED WITH A DEPOSIT.) OR my deposit of \$..... is enclosed (20% required), ship order C.O.D. for balance. NO C.O.D. ORDER FOR LESS THAN \$5.00. (New U. S. stamps, check or money order accepted.) Circle Item No. wanted: 33 87 159 160

Name .....

Address .....  
Please Print Clearly

City ..... State .....

Send remittance by check, stamps or money order; register letter if you send cash or stamps.

## A "VIEW OF THE FUTURE"

SIR LAWRENCE BRAGG, professor of experimental physics at the Cavendish Laboratory, Cambridge, England, says that war experience has revealed that it will presently be possible for sailors and airmen to see hundreds of miles ahead.

At the Cavendish Laboratory, known the world over as the birthplace of modern electrical knowledge, the professor is now engaged in the most secret war work of all. He said:

"There are adventures and discoveries in the realm of physical science, in the structure of this world and indeed of the whole universe, awaiting us just around the corner.

"Some of them, especially in the field of radio, are so startling that even those of us who have been studying these problems all our working lives are overawed."

Asked for a simple example of what such discoveries may mean to every man, he said:

"Can you picture a 'radio eye' which enables you to see all that is going on around you or anywhere? A radio lamp like a searchlight casting its beam ahead so that you can see some distant place or scene? Something quite apart from television.

"There will be no transmitter to send the picture to you. Your own receiver will stretch out and bring you the scene. It will be like a telescope or powerful field-glasses which bring the distant scene back in clarity.

"We know from war experience that it can be done.

"It will be possible, I believe, for the mariner and the airman actually to see what lies ahead, not merely for miles but for hundreds of miles.

"With the war over, when results of all our researchers can be released and when all nations co-operate in radio communication and development, 'radio eyes' may make travel by sea and air safe beyond all risk.

"Meanwhile, the problems in the realm of pure research in physics are mounting up. The Cavendish team of scientists, some seventy strong, was mobilized for the services. Our people are scattered the world over. Just what they have done toward beating the enemy in such things as radiolocation and in the development of radar, as we know it today, is a story for historians to tell later.

"There is not a man or a woman who would wish to be out of the direct war effort until their task is at an end."

### Editorial Comment on the Above

In the Radio Lexicon the word "impossible" should never be used, because in due time the art of radio has a habit of catching up with the most impossible theories.

Radio waves and electro-magnetic waves, to which light also belongs, are one and the same. If it is possible by means of a telescope to look at a star billions of miles away, it should not be too difficult to look around the curvature of the earth through the medium of radio waves over a distance a mere few hundred miles. Radio waves are reflected in a similar fashion to light waves, consequently if radio waves can be made visible, it should be possible to see objects hundreds of miles away through their instrumentality. It simply resolves itself down to the trick of transforming radio waves into light waves. Sooner or later it will be done. It certainly is not impossible.



Available from local dealers or by writing factory direct.

## UNIVERSAL STROBOSCOPE

This handy phonograph turntable speed indicator, complete with instructive folder, is now available gratis to all phonograph and recorder owners through their local dealers and jobbers. As a recorder aid the Universal Stroboscope will assist in maintaining pre-war quality of recording and reproducing equipment in true pitch and tempo.

Universal Microphone Co., pioneer manufacturers of microphones and home recording components as well as Professional Recording Studio Equipment, takes this means of rendering a service to the owners of phonograph and recording equipment. After victory is ours—dealer shelves will again stock the many new Universal recording components you have been waiting for.

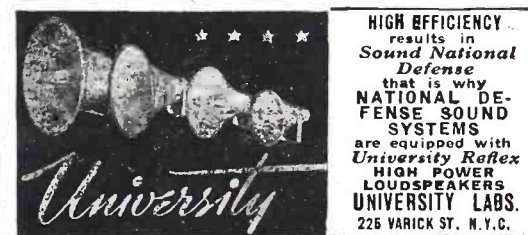

HIGH EFFICIENCY results in Sound National Defense that is why NATIONAL DEFENSE SOUND SYSTEMS are equipped with University REFLEX HIGH POWER LOUDSPEAKERS UNIVERSITY LABS. 225 VARICK ST. N. Y. C.

## OPPORTUNITY AD-LETS

Advertisements in this section cost 20 cents a word for each insertion. Name, address and initials must be included at the above rate. Cash should accompany all classified advertisements unless placed by an accredited advertising agency. No advertisement for less than ten words accepted. Ten percent discount six issues, twenty percent for twelve issues. Objectionable or misleading advertisements not accepted. Advertisements for November, 1944, issue must reach us not later than September 28, 1944.

Radio-Craft • 25 W. B'way • New York 7, N. Y.

SUBSTITUTION INSTRUCTIONS 300 CRITICAL tubes complete data \$1.50. Richard Jones, 1210 Dudley, Utica 3, N. Y.

PREPARE NOW FOR TREMENDOUS OPPORTUNITIES in new fields of radio after the war. Training for Federal licenses. Write for particulars. American Radio Institute, 44 East 23rd Street, New York 10, N. Y.

WANTED—LATE HALLICRAFTER SX-28 OR SX-25. Box 124, Somerset, Ky.

INVENTORS SELL YOUR IDEAS! SELECTED LIST 65 manufacturers anxious to buy inventions for postwar products, including special sales instructions. \$1.00 post-paid. Science and Mechanics Magazine, 822 St. Clair Bldg., Chicago 11.

USED CORRESPONDENCE COURSES AND TECHNICAL Books Bought, Sold, Rented. Catalog Free. Educational Exchange, Henager, Alabama.

Walkie-talkies were used for the first time by the Philadelphia Fire Department last July, in fighting fire in a chemical warehouse blaze. Radio communication was of special value due to the hazardous nature of the fire, which necessitated medical treatment of 150 firemen for scorched skins and smoke poisoning.

# NOW—A REALLY HIGH-POWERED— Radio Engineering Library

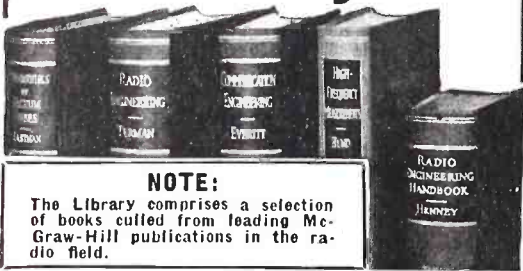

**NOTE:**

The Library comprises a selection of books culled from leading McGraw-Hill publications in the radio field.

- especially selected by radio specialists of McGraw-Hill publications
- to give most complete, dependable coverage of facts needed by all whose fields are grounded on radio fundamentals
- available at a special price and terms

THESE books cover circuit phenomena, tube theory, networks, measurements, and other subjects—give specialized treatments of all fields of practical design and application. They are books of recognized position in the literature—books you will refer to and be referred to often. If you are a practical designer, researcher or engineer in any field based on radio, you want these books for the help they give in hundreds of problems throughout the whole field of radio engineering.

**5 VOLUMES, 3319 PAGES, 2289 ILLUSTRATIONS**

1. Eastman's FUNDAMENTALS OF VACUUM TUBES
2. Terman's RADIO ENGINEERING
3. Everitt's COMMUNICATION ENGINEERING
4. Hund's HIGH FREQUENCY MEASUREMENTS
5. Henney's RADIO ENGINEERING HANDBOOK

10 days' examination. Easy terms. Special price under this offer less than books bought separately. Add these standard works to your library now; pay small monthly installments, while you use the books.

**10 DAYS' FREE EXAMINATION—SEND COUPON**

McGraw-Hill Book Co., 330 W. 42nd St. New York 18

Send me Radio Engineering Library, 5 vols., for 10 days' examination on approval. In 10 days I will send \$3.00, plus few cents postage, and \$3.00 monthly till \$24.00 is paid, or return books postpaid. (We pay postage on orders accompanied by remittance or first installment.)

Name .....

Address .....

City and State .....

Position .....

Company ..... RC 10-44

## 300 WAYS TO MAKE MONEY

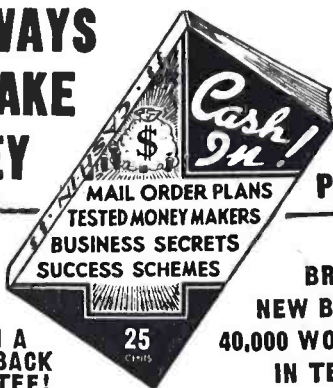

**25c**  
Per Copy

**SOLD ON A  
MONEY-BACK  
GUARANTEE!**

In "CASH IN" you get ALL the real money-makers—dozens of profitable tested mail order plans, confidential business secrets, dozens of practical tested formulas, successful tested schemes—actual experiences of men who have started on a shoestring—with less than \$10 capital.

**Buyers of This Book Tell Us—**

... "Biggest value I've yet to see. Book is worth at least a dollar." S. Buda, B'klyn, N. Y.

... "Your book is as good if not better than others selling at \$1.00."

George Brunet, Montreal, Can.  
... "CASH IN" is the best value I have yet to see in the mail order field."

Lawrence Fox, Brooklyn, N. Y.  
... "CASH IN" contains only tested ideas covering every type of full—or spare-time enterprise—it's a "masterpiece" in business ventures.  
25c a copy postpaid. Send U. S. stamps or coin.

**NATIONAL PLANS INSTITUTE**  
P.O. Box 26R, Station N  
New York 23, N. Y.

# The Mail Bag

## VOLUME EXPANDERS AND TRIODE CONNECTIONS

Dear Editor:

A reader, M.A.S., New York City, is somewhat perplexed with regard to the use of a 6SK7 in an Expander-Compressor circuit shown in the July, 1944, *Radio-Craft*. It happens that the writer has been interested in the problem of obtaining satisfactory expansion-compression for amplifiers. The following ideas may be of interest to you and the reader.

A 6SK7 tube has a control grid of special construction and is of the so-called super-control type of tube. The grid is wound with coarse spacing in the center and close spacing at the ends. When weak signals are applied, the action of the grid is essentially the same as for uniform spacing. When large signals are applied the electron flow through the ends of the grid is cut off, but as the signal increases the control effect becomes progressively less and even large signals will not reduce the plate current to cut off. In addition, the 6SK7 has greater uniformity of gain and more stable amplifier operation. If another type of triode tube were used the variable-mu feature of the 6SK7 would not be available, as this is obtained by

construction of the grid. As to the pentode connection, there is usually enough gain in most amplifiers and quality is by far the more important characteristic. The triode connection would give higher quality when operating as a Class A amplifier. By applying the proper fixed bias the operating point of the tube could be placed at the center of the linear portion of the tube characteristic curve. The 30,000-ohm resistor between the cathode and the B plus would accomplish this.

The January-February, 1942, *Radio-Craft* has an article on the Expander-Compressor, but, in this case, the plate, screen and suppressor are all tied together, and act as the plate. The 30,000-ohm resistor would also stabilize the operation of the tube, in addition to fixing the operating point.

GORDON ROBB,  
Minneapolis 9, Minn.

(The item mentioned above was a query in the July Question Box. The expander-compressor there referred to is the same as the one which was in the January-February, 1942, *Radio-Craft*.—Editor)

## HAM "REUNION" THROUGH RADIO-CRAFT

Dear Editor:

Several weeks ago the June issue of *Radio-Craft* reached my office. After finishing it I wrote on the front cover my name and call, and placed the magazine on the reading table of our London Traffic Office.

Just today I went by the office and I see written on the front cover of the same magazine the call letters and names of the following:

W1BFG	W2EYE
W3DPU	W8LTN
W8VQL	W9ANL

So, you see that *Radio-Craft* is being read by the "Hams Across the Sea."

JOSEPH D. ANDREW,  
Chaplain, Major  
W4EFG

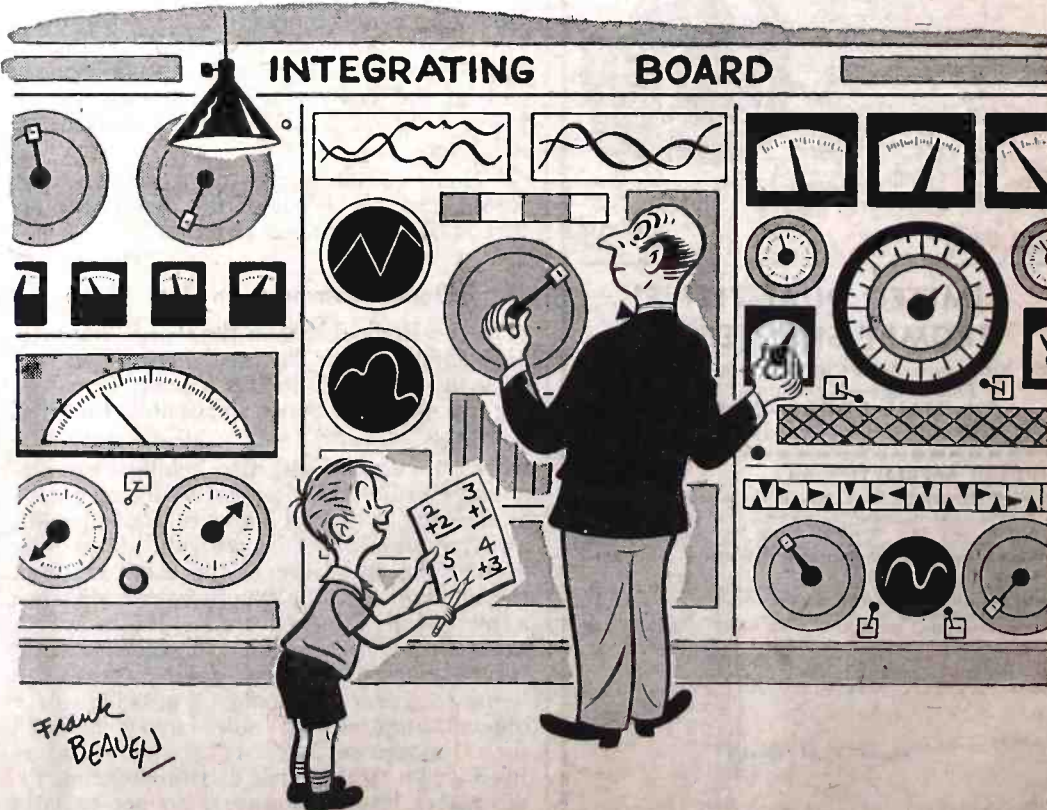

Frank BEAVER

"Pop, will you help me with my homework?"

## ELECTRONIC AIDS TO GOOD HEARING (Cont. from page 22)

cal and convenient, since portability is not a problem in this case.

Typical manufactured units will now be described.

### AUDIPHONE

These instruments are manufactured by the Western Electric Co. Two general types are available, carbon or vacuum-tube. In the first type, amplification results directly from the carbon button, but the second type

is particularly difficult to persons with one special type of hearing deficiency.

### OTARION

The transmitter weighs only 3 ounces and measures only 27/16" by 3 1/2" by 5/8". A frequency range with low distortion of from 100 to 7000 cycles is provided. Maximum gain of 63 db. occurs at 1750 cycles.

The hard-of-hearing person is first given a hearing test to determine his type of defect and the intensity at which pure tones

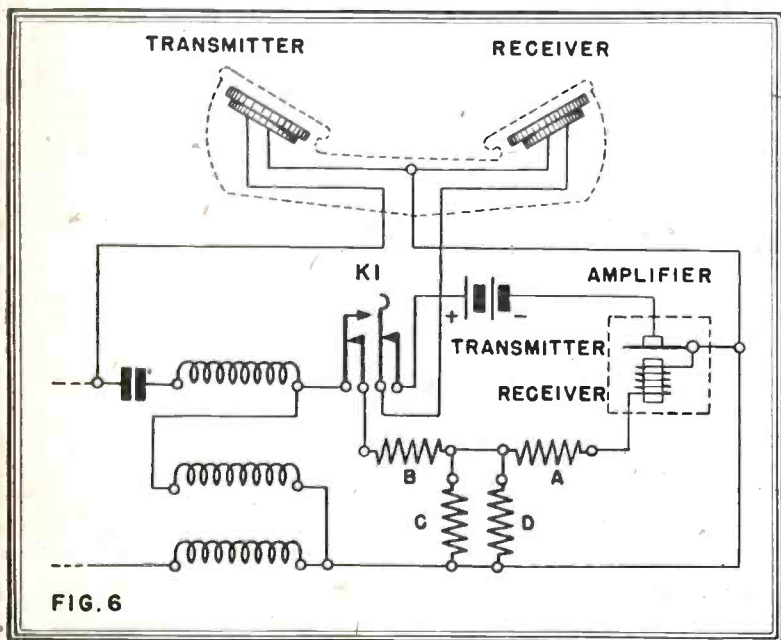

Fig. 6—A device to use with the ordinary line telephone. The non-electronic amplifier consists of a carbon-grain microphone.

must be used where more amplification is required. The Ortho-tronic or tube models make use of three miniature vacuum tubes. A crystal microphone is used. The tone discriminator has a three-position switch. For individuals with nerve impairment, this switch is adjusted to greatly amplify the high frequencies, while the lows remain at a reasonable level. Required batteries are a 1 1/2-volt and a 45-volt.

Prospective purchasers are first given an audiogram test from which the correct combination of units is determined for maximum satisfaction. Unrelated sentences from intelligibility lists are spoken and note is made of those not understood. Each sentence

of different frequency become painful. In this way, persons with nerve impairment who generally have less tolerance for loud sounds, as well as those with middle ear defects who generally have at least as great tolerance for loud sounds may both be fitted correctly. The low frequency tests show how much the amplification of the lows may be suppressed, while the middle frequency tests show the power required. Four general models are available: (1) for conductive impairment, (2) for nerve impairment (perceptive) and (3) mixed impairment with either conductive or perceptive predominating.

*(Continued on following page)*

## OF COURSE, YOU CAN'T PASS THE AMMUNITION — BUT —

You can see that ammunition gets right up there in perfect condition. How? By doing everything you possibly can to use less paper and to save wastepaper!

Don't ask your grocer to wrap factory-packaged goods, canned goods, bottled goods. Carry your own market bag or basket. Save every scrap of wastepaper and give it to your local paper salvage collector.



Remember—  
**PAPER IS  
WAR POWER**



**Use Less Paper—Save All Wastepaper**

*This advertisement contributed by this publication and prepared by the War Advertising Council in cooperation with the War Production Board and the Office of War Information.*

**4 STANDARD TYPES**  
of Amperite Regulators replace over 400 types of AC-DC Ballast Tubes now in use.

Amperites are real REGULATORS... have patented Automatic Starting Resistor which prevents initial surge and saves pilot lights... Ask Your Jobber.

# AMPERITE

THE *Simplest* WAY TO REPLACE BALLASTS

WRITE FOR REPLACEMENT CHART

AMPERITE Co. 561 BROADWAY, NEW YORK, N. Y.

## RADIO-ELECTRONICS HOME-STUDY COURSE

New home-study course in 3 volumes. Covers every topic of radio and electronics. Brush-up on useful radio fundamentals, use the practical service hints, prepare for a future in Electronics and Radio.

- Volume 1. Fundamentals of Radio and Electronics. Use the 13 lessons of this volume to really understand radio and electronics. Parts, tubes, circuits, tests, 172 large pages, all lessons size 8 1/2 x 11", with instructor's tips, 201 charts and pictures, index... **\$1.50**
- Volume 2. Receivers, Transmitters, & Test Equipment. Superhets, communication receivers, oscillators, transmitters, repair, adjustment, antennas, meters, electronic test equipment, signal tracers, AFC, television, and other topics. In 9 large lessons and index, 103 help-ful illustrations. Large size: 8 1/2 x 11 inches... **\$1.50**
- Volume 3. Applied Electronics and Radio Servicing. Lessons on photo-cell equipment, special radio receivers, radio compass, frequency meters, life-boat transmitter, U.H.F. heating, electronic shaping circuits, aircraft direction finders, absolute altimeter, radar, metal locators, special tubes, welding controls, voltage regulators, X-rays, magnetron, electronic gages, facsimile, recording, inter-comms. Also lessons on radio servicing, case histories, diagrams. Manual contains 31 large lessons. **\$1.50** Size: 8 1/2 x 11 in., 102 illustrations, index... **\$1.50**
- All 3 Volumes, 53 Lessons, only... **\$3.95**

Clip this ad. Check manuals wanted. Enclose your remittance. Books sent postpaid. Money back guaranteed.

**SUPREME PUBLICATIONS**  
328 S. Jefferson St. Chicago 6, ILL.

# SUBSTITUTE AVAILABLE TUBES QUICKLY!

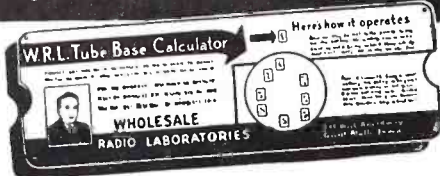

## WITH THIS HANDY TUBE-BASE CALCULATOR

Send Only 25¢ **Special Get-Acquainted Offer!**

Thousands of service men, experimenters and amateurs have already taken advantage of this offer. Easy to use, this calculator tells you tube characteristics that enable you to substitute available tubes for those hard to get. Send for yours today. Postpaid, only 25c.

## FREE! GIANT WALL-SIZE RADIO REFERENCE MAP

Here's a gift from Leo—W9GFQ—that you'll want. Size 3½ by 4½ ft. Map has time charts, station list, amateur zones, networks, world shortwave, etc. Yours free. Send 15c to help with mailing and packing.

## Try LEO for Hard-To-Get Radio Parts

You'll be surprised at the many hard-to-get parts I have been able to obtain for you fellows. They're yours as long as they last. Send today for my latest flyer. It's full of merchandise you've been trying to get. Stocks won't last long, so send today.

## I WANT HALLICRAFTERS

I'll pay the highest cash price for that equipment you're not using. I'm especially interested in any Hallicrafters sets you have but I'll buy other makes of equipment, too. Tell me what you have—I'll quote top price.

## WHOLESALE RADIO LABORATORIES

744 W. Broadway, Council Bluffs, Ia.

Leo—W9GFQ—Dept. RC10 MAIL COUPON TODAY  
Wholesale Radio Laboratories  
744 W. Bdw., Council Bluffs, Iowa

- You bet I want one of the tube-base calculators. Here's my 25c.
- While you're at it, send your free radio map. 15c is enclosed for mailing and packing.

Name .....

Address .....

Town ..... State .....

I am a  service man;  experimenter;  amateur.

## Choose the CANNON-BALL HEADSET



### You Like Best

Rugged construction. Inside or outside terminals. Sensitive. Clear tone. Dependable quality. Headset Headquarters guarantees satisfaction. Write for folder R-10.

C. F. CANNON COMPANY  
SPRINGWATER, N. Y.

## USED Correspondence Courses

Complete HOME-STUDY Courses and self-instruction books, lightly used. Rented, sold, exchanged. All subjects. Satisfaction guaranteed. Cash paid for used courses. Full details & 92-page illustrated bargain catalog Free. Write now.

NELSON CO., 321 So. Wabash Ave., Dept. 2-39, Chicago 4, Ill.

(Continued from previous page)

## RADIONIC AID

The Zenith Radio Corp. has recently entered the hearing aid field with a popularly priced instrument. This uses two vacuum tubes, crystal microphone, magnetic receiver. The tone control has 4 positions so that a complete range of adjustment is obtainable. Automatic volume control prevents blasting on loud signals.

There is also available a small A.C. power pack which may be used in semi-permanent installations, such as in a school room, at home, or in the office. This eliminates wearing out of batteries when so located.

## AUROPHONE

This model is manufactured by the Mears Radio Hearing Device Corp. The transmitter weighs 1½ ounces. With batteries the Auropak weighs 5½ ounces, the receiver and cord weighing ¾ ounces. It is possible to attach the batteries to the transmitter in one unit, thus eliminating need for a battery cord.

The device uses three vacuum tubes, crystal microphone and adjustable tone control.

## TELEPHONE

It is now possible for a hard-of-hearing person to converse normally over the telephone with the aid of this unit. All parts except a 4½-volt battery are incorporated in the base of the telephone. Amplifier gain is adjusted by turning one of the switch-hook plungers, the same plunger also containing a switch for disconnecting the amplifier. The amplifier consists of a granular-carbon microphone with diaphragm actuated by a bipolar receiver. Diagram is shown in Fig. 6. The T network controls the gain. Its elements are varied by rotating the plunger as stated. A total of 25 db. gain is provided.

**FORECAST** of renewed civilian production of radios and phonographs was seen in last month's OPA revoking price schedules on consumer-type radio receivers and radio-phonographs.

These articles have now been placed in the same class as other consumers' durable goods, and will be covered by regulations applying to them. Since the present price schedules were devised to cover items on hand in 1942, they would not be adapted to the pricing of new models made under present cost conditions.

Vice Chairman C. E. Wilson of the WPB, warning that no civilian radios would be produced before the surrender of Germany, stated that many governmental controls might be removed after that time and "the overall war production program probably would be reduced by about 40 per cent."

Another straw in the wind is the recent WPB order permitting the making of experimental models of a number of items, including (among such things as automobiles and passenger airplanes) radios, television receivers and juke boxes. These experimental models are to be for engineering and design purposes only.

Although no hope of immediate or even early supplies of civilian radios has been held out, the action clearly indicates that consideration of consumer manufacturing problems is now topical.

Hopeful manufacturers have been warned, however, that the radio-radar production program for 1944 must continue upward through next December and about 16.4 per cent above the July output rate. Army and Navy officials concurred in this estimate of overall increase during the rest of the year.

## PATENTS—TRADE MARKS

Booklet concerning Inventions & Patents Form "Evidence of Conception" with instructions for use and "Schedule of Government and Attorneys Fees"—Free  
LANCASTER, ALLWINE & ROMMEL  
Registered Patent Attorneys

436 Bowen Bldg.

Washington 5, D. C.

## Index to advertisers

Allied Radio Corp.	58
Amperite Corporation	61
Audel & Company	41
Best Vibrator Co.	54
Burgess Battery Co.	47
Burlingame Associates	43
Burstein-Applebee Co.	44
Cannon Co., C. F.	62
Capitol Radio Engineering Institute	48
Cardwell Mfg. Co., Allen D.	56
Chartered Institute of American Inventors	44
Coyne Electrical School	44, 55
Cox, John A.	54
DeForest's Training	7
Echophone Radio Co.	39
Electro-Voice Mfg. Co.	45
Fada of New York	44
Federal Telephone & Telegraph	56, 57
Galvin Mfg. Co.	57
General Cement Mfg. Co.	54
General Electric Co.	46
Hallicrafters Co., Inc.	3, 4
Harrison Radio Corp.	49
Hazeltine Electronics Corp.	57
Henry Radio	49
Hudson Specialties	50, 59
International Resistance Co. Back cover	
Lancaster, Allwine & Rommel	62
McGee Radio Co.	55
McGraw-Hill Book Co.	60
Meissner Mfg. Co.	6
National Plans Institute	60
National Radio Institute	1
National Schools	9
National Union Radio Corporation	8, 56
Nelson Company	62
Ohmite Mfg. Co.	50
Onan & Sons, D. W.	54
Opportunity Adlets	59
Panoramic Radio	10
Popular Homecraft	44

## RADIO SCHOOL DIRECTORY Page 64

Candler System  
Capitol Radio Engineering Institute  
Commercial Radio Institute  
Lincoln Engineering School  
N. Y. Y.M.C.A.  
Radio & Television Institute  
RCA Institutes

Radcraft Publications, Inc.	55
Radio Corporation of America	33
Radio & Technical Division	
Murray Hill Book Co.	34, 35
Radio Tube Service Co., Inc.	51
Raytheon Mfg. Co.	Inside back cover
Solar Mfg. Co.	Inside front cover
Sperry Gyroscope Co., Inc.	57
Sprague Products Co.	37
Sprayberry Academy of Radio	5
Supreme Publications	61
Sylvania Electric Co.	52
Universal Microphone	59
University Laboratories	59
Western Electric Co.	56
Weston Electrical Instrument Co.	53
Wholesale Radio Laboratories	62

(While every precaution is taken to insure accuracy, we cannot guarantee against the possibility of an occasional change or omission in the preparation of this index.)



# BOOK REVIEWS

**BASIC MATHEMATICS FOR ENGINEERS**, by Paul G. Andres, Hugh J. Miser and Haim Reingold. Published by John Wiley and Sons. Stiff cloth covers, 6 x 8½ inches, 726 pages. Price \$4.00.

This text—according to the preface—“presents the mathematics required for the intelligent pursuit of elementary engineering courses.” It is a compendium of such topics from the various branches of mathematics as are needed by the engineer. A secondary aim of the book is to prepare the student for a course in calculus.

Algebra, trigonometry, plane and solid analytic geometry, vectors, the  $j$  operator, and elements of differential and integral calculus are among the most important subjects included.

The start is made at ground level, with positive and negative numbers. The author suggests that the book is intended to be used by students who have had at least two years of high school mathematics, but the intelligent student familiar with ordinary arithmetic will have little difficulty with it. The language is simple, and the book is almost completely self-contained. There is even a digest of the salient points of geometry (in the Appendix) for the student who may be ignorant of that subject.

The approach is practical as well as simple. Use of the slide-rule is explained in the first chapter, and subjects are introduced in the order in which they are needed, no attention being paid to the traditional order of the older textbooks. Graphs are introduced in the third chapter, and graphical methods have a prominent place from that point throughout the book.

A number of useful mathematical tables are found in the Appendix.

**RADIO SERVICING MADE EASY**. By M. N. Beitman. Published by Supreme Publications. Paper covers, 8½ x 11 inches, 44 pages. Price 25 cents.

Directing his attention to the very beginner in servicing, the author begins this booklet with instructions to obtain a radio and dismantle it. The student is given pictures (most of them good photographs) of the various components he will find, and an explanation of the function of each one. Simple explanations of inductors, condensers and transformers follow. Next are vacuum tubes and a section on power supplies. Audio and radio amplifiers and detectors are then treated. The book ends with schematics and notes on a TRF and superheterodyne receiver, and a description of test apparatus.

The system—originated in an earlier work—of running a wide margin down the outside of the page and putting in more important notes, explanations, kinks and thought-provokers is followed in this booklet. The result is a valuable emphasis on the more important points.

Thirteen pages of the book are occupied with a Sylvania tube data section, giving characteristics and base diagrams of receiving tubes and panel lamps.

**SHOP JOB SHEETS IN RADIO, Book II—Service Problems**, by Robert Neil Auble. Published by the Macmillan Co. Flexible fiber cover, board back. 8½ x 11 inches, 128 pages. Price \$1.50.

Sequel to the author's “Shop Job Sheets in Radio,” this volume is designed to give the student who has mastered the material covered in the earlier book a chance to apply the principles to standard radio equipment. The approach, as in Book I, is practical. The first five experiments are confined to the important work of testing radio components—resistors, condensers, transformers, chokes and tubes being taken in turn.

The student is not limited to the cruder aspects of servicing. Certain of the experiments call for running response curves on audio amplifiers, the use of variable audio frequency signal generators, level meters, the cathode-ray oscillograph and other secondary servicing instruments.

Charts are printed right in the book, thus supplying log or straight graph paper as required.

Much attention is paid to the almost universal superheterodyne receiver. Nine of the twenty-five experiments are devoted to this subject, running from fundamental principles through a detailed study of each unit to alignment procedure. Standard radio receivers are recommended for study, though the construction method is used for simpler units. Experiments on the construction of a power supply, high-gain amplifier stage and a power amplifier of the phase-inverter type are included.

The last six experiments are on transmitters. Three types of oscillators are studied, then R.F. amplifiers, frequency doublers, power supplies and modulation circuits.

The references to standard texts included with each experiment, as well as the “Topics for Classroom Discussion” which were a valuable feature in Book I, are continued in this second volume.

**RADIO AUDIENCE MEASUREMENT**, by Matthew N. Chappell and C. E. Hooper. Published by Stephen Daye. Stiff cloth covers, 5½ x 8 inches, 246 pages, plus 22 pages of introduction, preface, lists of charts, tables, and contents. Price \$3.50.

The technique of radio audience measurement, upon which the livelihood of the radio industry depends, is fast becoming something approaching an exact science. While crude attempts at discovering the size of the listening audience have been made ever since the earliest days of broadcasting, it was only in 1929 that Archibald Crossley attempted a systematic sampling technique. Clark-Hooper entered the field in 1934, with a different method, which has developed into the Hooper survey of broadcast listening.

Written by two of the leading practitioners of the “co-incidental” method of audience sampling, in which the listener is queried by telephone while he is actually listening to the program, the book is naturally weighted toward that system. Two full chapters are devoted to the method, as well as considerable matter in other chapters. Other systems are not neglected, however.

The recall method is discussed and its evolution described, together with notes on its advantages and shortcomings. The different types of recall are dealt with and compared.

Space is also given to less well-known methods of audience measurement—the mechanical recorder being the chief of these. While this device falls far short of either the co-incidental or recall sampling methods in some respects, yet it “is capable of gathering some data which cannot be obtained by any other method and it yields more reliable measures of some audience characteristics than can be obtained by other methods.” Listener panels are covered, and there is an illuminating chapter on the use of two or more methods in combination.



“I use a two-way radio this trip!”

# RADIO SCHOOL DIRECTORY

PREPARE NOW FOR POST-WAR RADIO AND ELECTRONICS

MAKE a place for yourself in a new world of radio and electronics—a world in which revolutionary electronic developments will require highly specialized technical knowledge. Take a good course now to fit yourself for a good paying job. The training you need can be supplied by one of the schools advertised in this publication.

**RADIO . . . TELEVISION ELECTRONICS**

TRAIN NOW for postwar opportunities in this VAST, NEW field! Classes day and evening. Call daily 9-9—Sat. 9-2, or write Dept. RC.

**RADIO-TELEVISION INSTITUTE**  
480 Lexington Ave. (46th St.), New York, N. Y.  
PLaza 3-4585 Licensed by N. Y. State

**COMMERCIAL RADIO INSTITUTE**

A radio training center for twenty-four years.

ACCREDITED FOR VETERAN TRAINING  
RESIDENT COURSES ONLY

Pre-Induction, Broadcast, Service, Aeronautical, Television and Marine telegraphy classes now forming for fall term Oct. 9. Literature upon request.

Home Study Course in Mathematics

Dept. C., 38 West Biddle St., Baltimore 1, Md.

**RADIO TECHNOLOGY**



RCA Institute offers an intensive two-year course of high standard embracing all phases of Radio and Television. Practical training with modern equipment. Also shorter specialized courses in Commercial Radio Operating, Radio and Television Servicing, and Aviation Communications. For Free Catalog write Dept. RC-44.

**RCA INSTITUTES, Inc.**

A Radio Corporation of America Service  
78 VARICK STREET NEW YORK 13, N. Y.

**Pre-Induction RADIO COURSES**  
for Civilians and those entering Military Services. New classes now starting for men and women.

- RADIO OPERATING
- RADIO SERVING — ELECTRONICS
- CODE

New York Y.M.C.A. Schools  
4 W. 64th Street New York City

**CODE SENDING SPEED**  
**CODE RECEIVING SPEED**

Be a "key" man. Learn how to send and receive messages in code by telegraph and radio. Army, Navy and Commerce needs thousands of men. Good pay, adventure, interesting work. Learn at home quickly through famous Candler System. Write for FREE BOOK.

**CANDLER SYSTEM CO.**  
Dept. 3-L, Box 928, Denver 1, Colo., U.S.A.

**LES Correspondence Courses in RADIO and ELECTRICAL ENGINEERING**

**ELECTRICAL ENGINEERING** Get good grasp of wide electrical field. Prepare yourself, at Low Cost, for secure future. Modern, simplified, you can understand quickly.

**RADIO ENGINEERING** Extra fine course in radio, public address, photo-electric work. Trains you to be super-service man, real vacuum tube technician. Servicemen needed badly. Diploma on completion. Tuition \$25, either course. Deferred payment plan.

**FREE** Get copies of school catalogs, student magazines, complete details. SEND NOW!

**LINCOLN ENGINEERING SCHOOL** Box 61-067, Lincoln, Nebr.

• • • **LOOK AT THE CAPITOL RADIO ENGINEERING INSTITUTE** • • •  
**MESSAGE ON PAGE 48**

3. Include proof of discharge—photostatic copies if possible. These will be returned by WPB after verification.  
The War Production Board will be glad to do anything they can to help these men in returning to their normal civilian activities.

**WPB-541 (former PD-1A) Application for Priority Assistance.** This form can be used to apply for priority assistance which the applicant is not otherwise authorized to extend. It is to be used only where circumstances urgently require special assistance of direct or indirect importance to the war effort, such as replacement of equipment lost in a fire, etc. It is not to be used in such cases where Limiting, Scheduling, Conservation, or other such orders specify the use of other forms, however. It is best to consult with your WPB Field Office before making application on this form.

**CMP Regulation No. 9A.** This regulation sets up a procedure whereby the serviceman can purchase parts and controlled materials for making repairs or rebuilding a damaged or used item which he plans to resell. Such parts, however, must not be used merely to improve performance. This order as amended April 15, 1944, does not include Capacitors, Microphones, Loud-speakers, Resistors, Volume and Tone Controls, Transformers and Tubes. Copies may be obtained from your WPB Field Office.

The following certification must accompany the order:

**CMP Allotment Symbol V-3; Preference Rating AA-3.** The undersigned purchaser certifies subject to the penalties of section 35(A) of the United States Criminal Code, to the seller and to the War Production Board, that, to the best of his knowledge and belief, the undersigned is authorized under applicable War Production Board regulations or orders to place this delivery order, to receive the items ordered for the purpose for which ordered, and to use any preference rating or allotment number or symbol which the undersigned has placed on this order.

Signature and Date

**CMP Regulation No. 5.** This regulation sets up procedure for obtaining maintenance, repair and operating supplies, and minor capital additions not exceeding \$500.00 for any one such addition. The following certification must accompany the order:

**Preference Rating AA-5 MRO.** The undersigned certifies, subject to criminal penalties for misrepresentation contained in section 35(A) of the United States Criminal Code, that the items covered by this order are required for essential maintenance, repair or operating supplies; that this order is rated and placed in compliance with CMP Regulation No. 5; and that the delivery requested will not result in a violation of the quantity restrictions contained in paragraph (f) of said regulation.

Signature and Date

Mr. Carrington and *Radio-Craft* will be glad to clear up any points not fully explained in the above article. Remember first, however, that your Field Office may be the correct body to write to, and only when you do not understand the regulations well enough to write intelligently to that office, or if you are not clear as to your rights, classification, etc., should you inquire from us. Address all letters on this subject to: Priorities, c/o *Radio-Craft*, 25 West Broadway, New York 7, N. Y. A list of WPB field offices is shown on page 31.

**PRIORITIES (Continued from page 31)**

tions for filing. They will also supply WPB-541 forms.

**CERTIFICATIONS AND PROCEDURE**

**L-265 General Limitation Order.** This order regulates the delivery of electronic equipment. Its basic stipulations are that no producer or supplier shall transfer electronic equipment to the

**T**HE radio serviceman just starting up in business is often disturbed by such terms as *L-265*, *CMP 9-A* and *Certification V-3*. After calling on—or corresponding with—his WPB field office, he learns that these terrifying terms are simply the names of bulletins telling him what he can obtain and how, or statements which he must make and attach to each of his orders to his distributor, declaring that he is a bona-fide serviceman and entitled to obtain the goods ordered (*Certification V-3*) or that the parts are required for the repair of apparatus in his possession (*L-265*). He does find, however, that many articles require other priorities, for which special forms must be filled out—as for instance in the purchase of test equipment or installation of industrial sound systems—and he may not always be sure as to the procedure to be followed in a given case. This article is an attempt to help him solve some of these problems.

consumer except to fill preferred orders (from the armed services and others operating in direct support of the war effort), orders rated at AA-5 or higher, or orders for electronic replacement parts where the consumer submits a defective or damaged part of similar kind and size which cannot be repaired or reconditioned. Where this is impractical, a signed certificate in the following form should accompany the order:

**Consumer's Certificate—(Purchases for Own Use)**

I hereby certify that the part(s) specified on this order are essential for the presently needed repair of electronic equipment which I own or operate.

Signature and Date

**Supplier's (Serviceman's) Certificate—(Purchases for Resale)**

I hereby certify that I am entitled to purchase the items specified on the accompanying purchase order under the provisions of Limitation Order L-265, with the terms of which I am familiar.

Signature and Date

**Note to War Veterans:** Radiomen returning to civilian life who have been discharged from the Armed Services may obtain release from the L-265 Limiting Order in the following manner:

Those men who have been in the Radio Service business and depleted their stock of radio tubes and component parts because of entering into the Armed Services, may obtain permission to purchase a new stock by submitting a letter to the Radio and Radar Division of the War Production Board, Washington, D. C., furnishing the following information:

1. Quantity and type of radio component parts which are required to establish them in business that was being done previous to their military duty.
2. Supply the name of the distributor with whom the order will be placed.

**\$3.00 FOR YOUR IDEA**

**RADIO-CRAFT**, as you will have noticed, prints a number of radio cartoons, which we intend to keep on publishing every month indefinitely. We invite our readers to contribute to this feature by sending in their ideas of humorous radio ideas which can be used in cartoon form. It is not necessary that you draw a sketch, but you may do so if you so desire.

**RADIO-CRAFT** will pay \$3.00 for each original idea submitted and accepted.

We cannot return ideas to this department nor can we enter into correspondence in connection with them. Checks are payable on acceptance.

Address all entries to **RADIO CARTOONS**, c/o **RADIO-CRAFT**, 25 West Broadway, New York 7, N. Y.

FOR *Dependability*  
 IN ANY EMERGENCY  
 THEY RELY ON  
**RAYTHEON**  
 TUBES

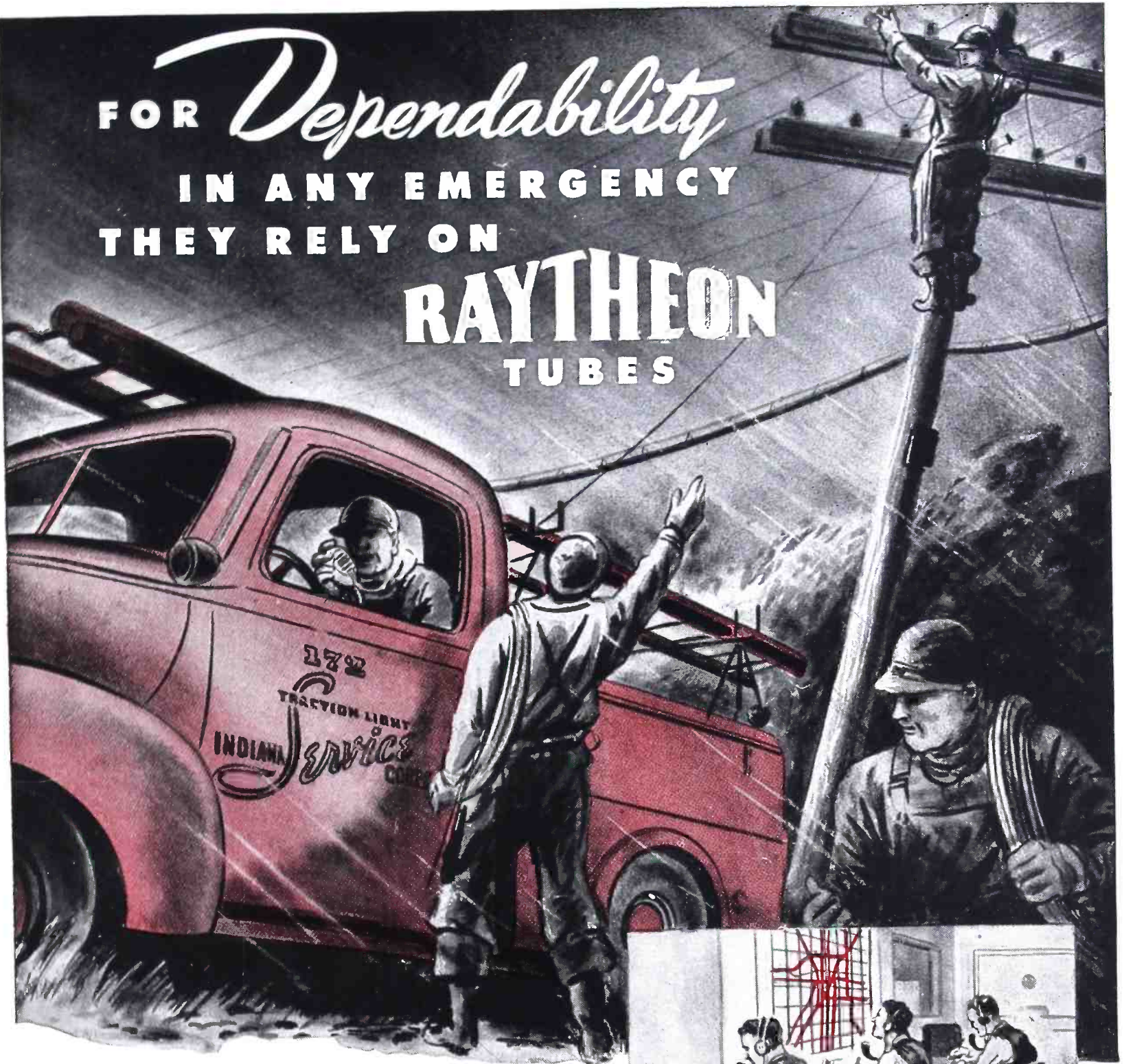

In a busy industrial city like Fort Wayne, Indiana, it is necessary that any interruption in electric service be remedied immediately. INDIANA SERVICE CORPORATION which supplies electric light and power to Fort Wayne's war plants, has found that two-way radio between the dispatcher's office and service, patrol and repair trucks assures the quickest and most reliable means of communication in any emergency. To assure even greater reliability, this electronic communication system is equipped with RAYTHEON high fidelity tubes.

That "Plus-Extra" quality that proved RAYTHEON the best tube in the past, will be enhanced with all the knowledge that is being gained from manufacturing advanced electronic equipment for the war effort. This wartime

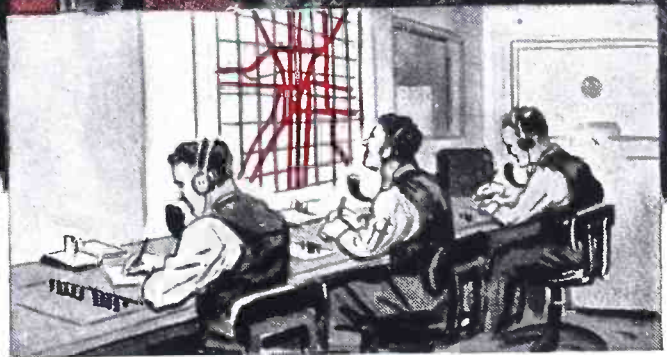

experience will doubly guarantee that you will be able to offer your customers the best engineered and precision-made electronic tubes for all applications. In the meantime, RAYTHEON will continue to supply you with all the MR tubes that WPB allows, for you to pass on to those who need them most.

**Raytheon Manufacturing Company**

RADIO RECEIVING TUBE DIVISION

Newton, Massachusetts • Los Angeles • New York • Chicago • Atlanta



All Four Raytheon Divisions Have Been Awarded Army-Navy "E" Plus Stars

**RAYTHEON**  
*High Fidelity*  
 RADIO AND ELECTRONIC TUBES



DEVOTED TO RESEARCH AND MANUFACTURE OF TUBES FOR THE NEW ERA OF ELECTRONICS

HOW BUSINESSES ARE RUINED --



**Lets Be Reasonable**  
by don herold

The wisest thing Abraham Lincoln ever said was: "This, too, will pass." I forget what he said it about. But it was some kind of trouble.

The smartest thing any of us can say about this war is: "This, too, will pass."

If we're wise, we'll figure on still being in business at the same old stand with the same old customers, and some new ones that the satisfied old ones have sent in.

So let's be reasonable. Reasonable (to ourselves and to our customers) in prices. Reasonable in our attitudes. Reasonable in our conduct toward our public.



If possible, we should make some money. There is no point to pleasing customers if we aren't going to be here when they come back for more. We're all entitled to fair mark-up on our merchandise.

I like to see even my competitor make money. It's better for two

of us guys to be making honest money in a community than for both of us to go broke in a big way.



HOW BUSINESSES ARE BUILT

On the other hand, nobody ever got rich selling the Brooklyn Bridge. There's no future in it. If we overcharge anybody during the war, we'll never see him after that armistice.

"This, too, will pass." Let's be here with a lot of old and new friends, when it does.

No. 8 in a series of special messages prepared by America's famous business writer, humorist and cartoonist, Don Herold. . . . In sponsoring these Don Herold "broadcasts," IRC pays tribute to the thousands of Radio Service Men who, whenever possible, specify and use IRC resistance units in their work.



**INTERNATIONAL RESISTANCE CO.**

401 N. Broad St. - Philadelphia 8, Pa.

IRC makes more types of resistance units, in more shapes, for more applications than any other manufacturer in the world.



# ADV Plans, LLC

## Copyright Notice:

The entire contents of this CD/DVD are copyright 2014 by ADV Plans, LLC. All Rights Reserved.

Reproduction or distribution of this disk, either free or for a fee is strictly prohibited. We actively monitor and remove listings on eBay thru Vero.

You are free to copy or use individual images in your own projects, magazines, brochures or other school projects.

Only the sellers listed here are authorized distributors of this collection:  
[www.theclassicarchives.com/authorizedsuppliers](http://www.theclassicarchives.com/authorizedsuppliers)

Please view our other products at  
[www.theclassicarchives.com](http://www.theclassicarchives.com),  
or our ebay stores:

[TheClassicArchives](#)  
[ADVPlans](#)  
[SuperShedPlans](#)

